

Molding Profiles - Miscellaneous

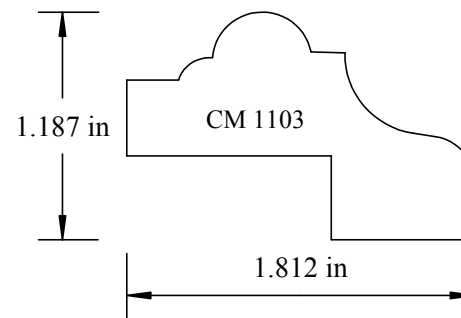

Molding Profiles - Miscellaneous

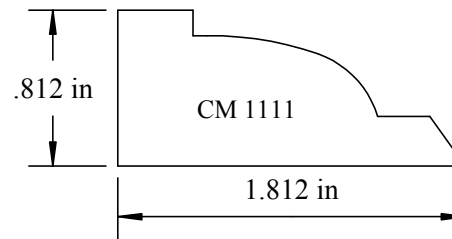
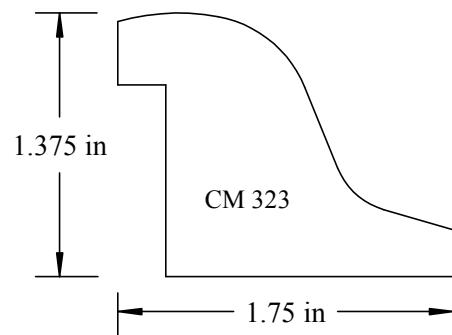
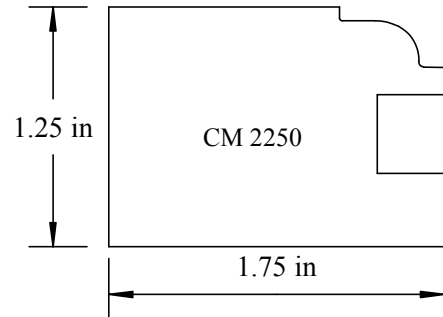
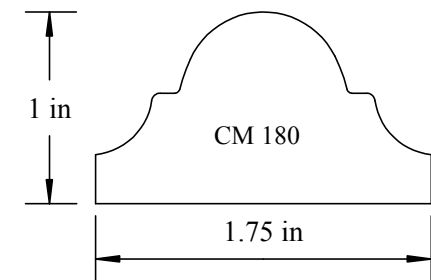
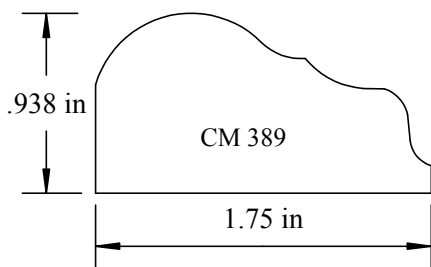
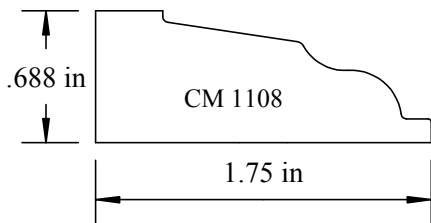
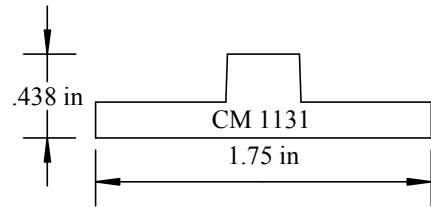
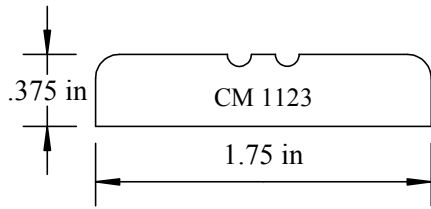
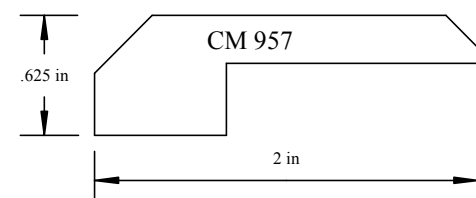
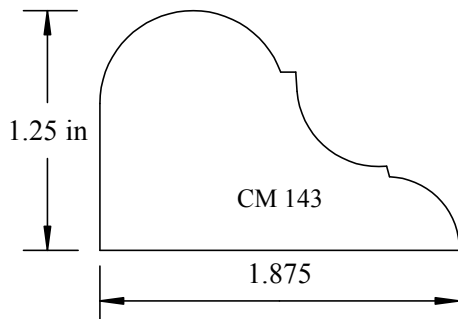
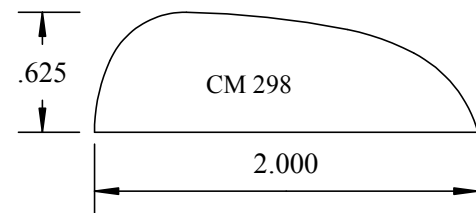
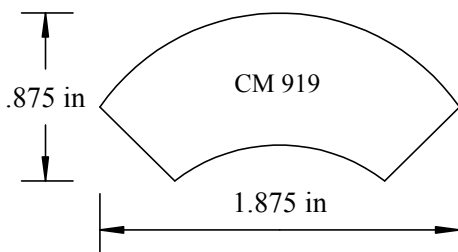
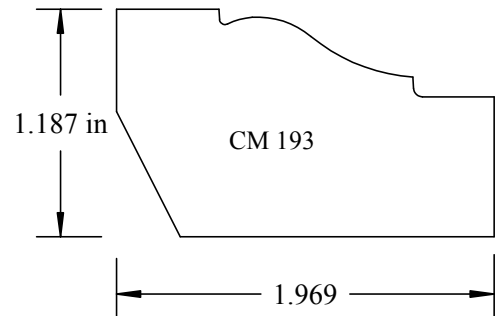
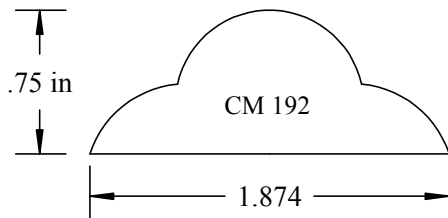
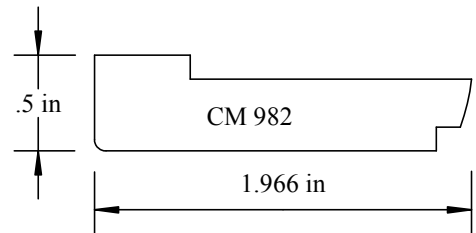
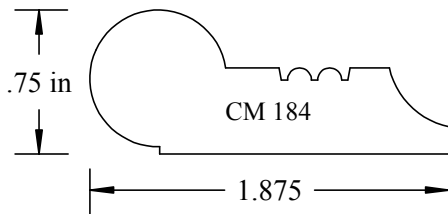
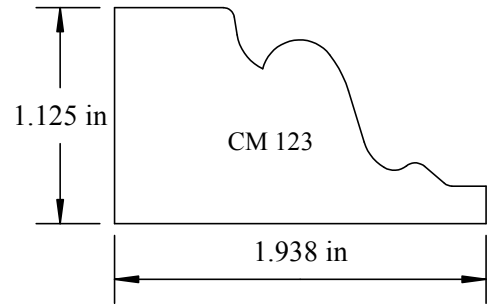
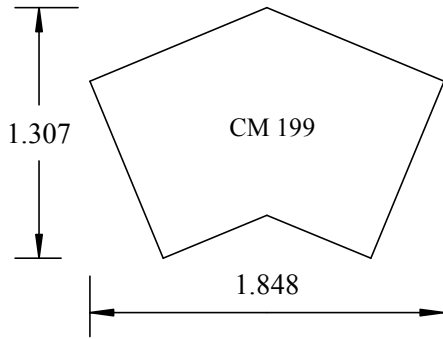

Molding Profiles - Miscellaneous

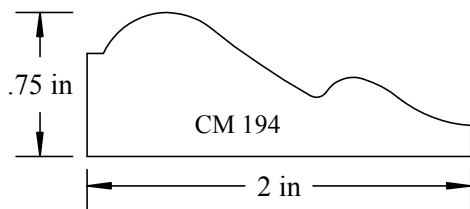
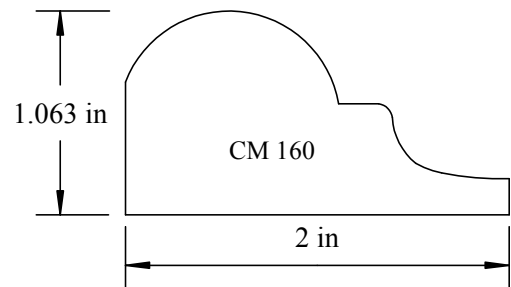
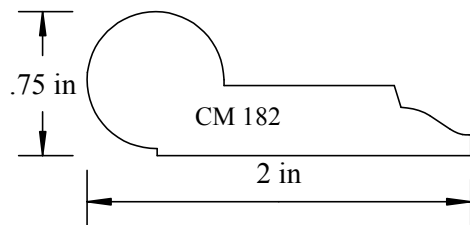
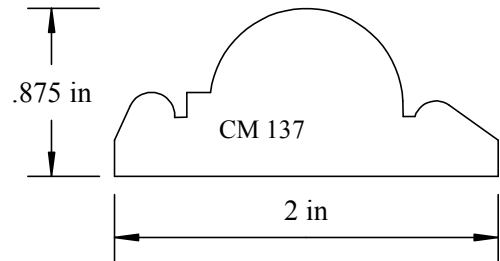
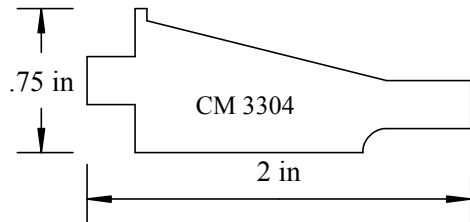
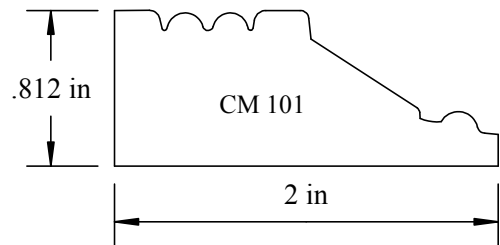
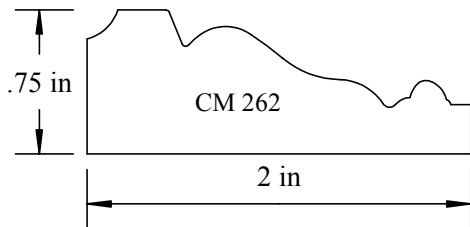
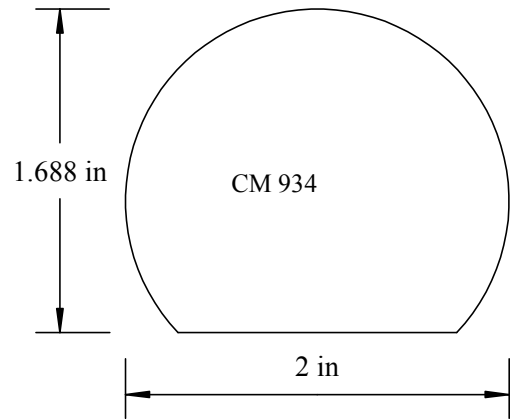
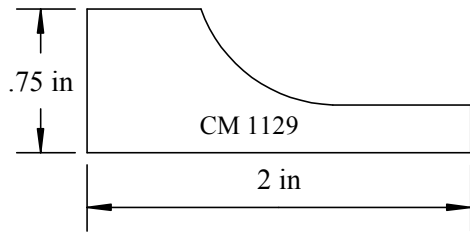

Molding Profiles - Miscellaneous

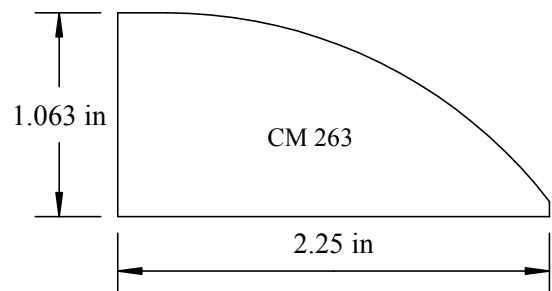
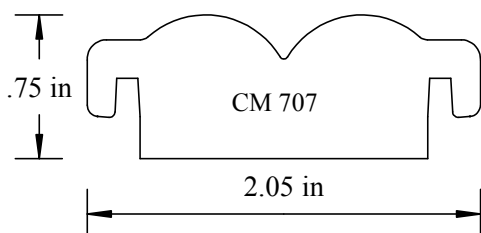
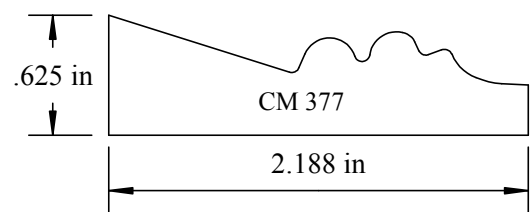
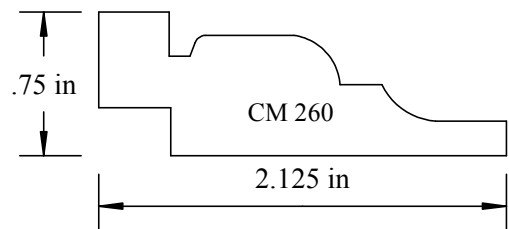
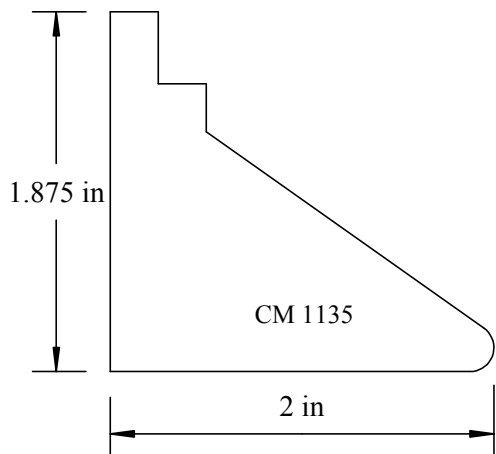
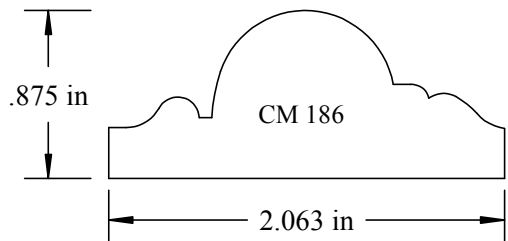
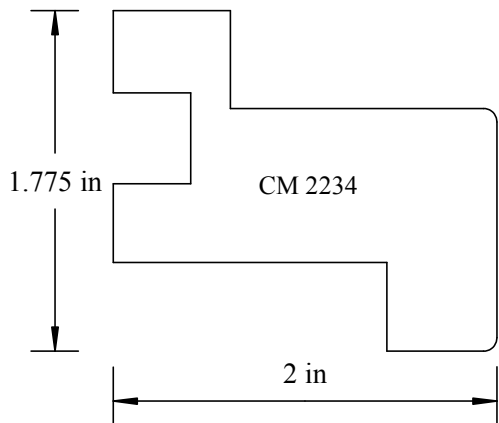
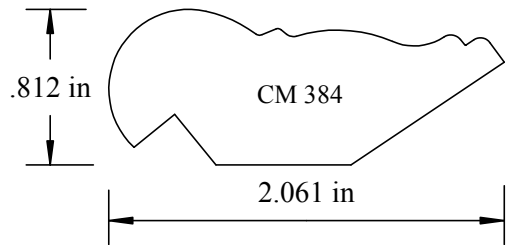
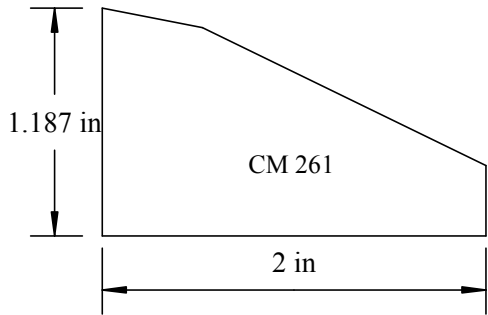

Molding Profiles - Miscellaneous

