

Molding Profiles - Crowns

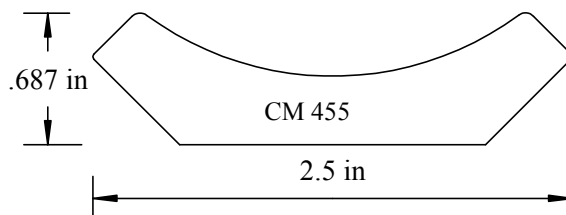

Molding Profiles - Crowns

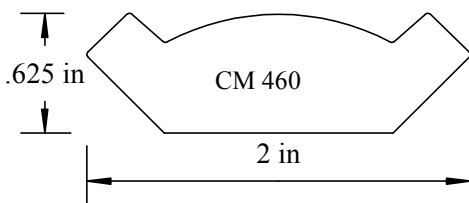
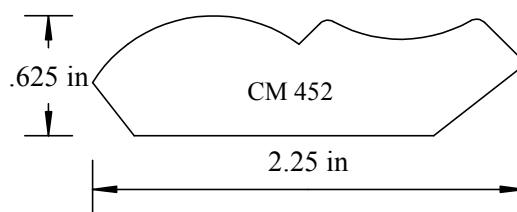
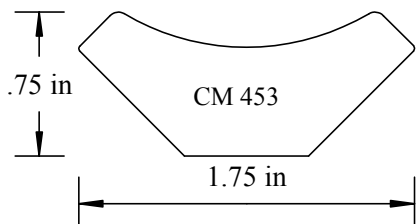
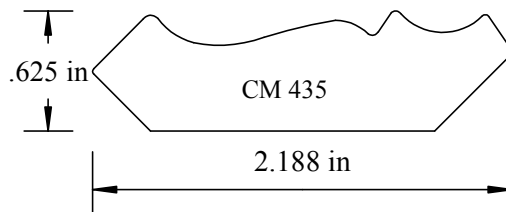
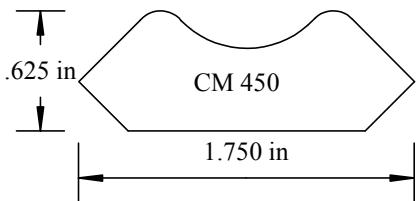
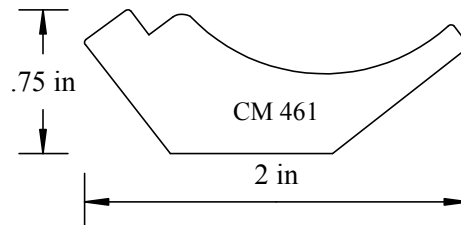
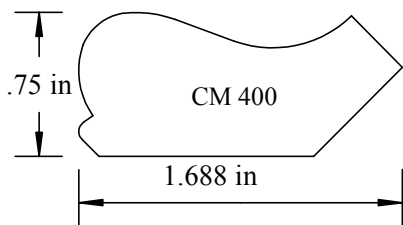
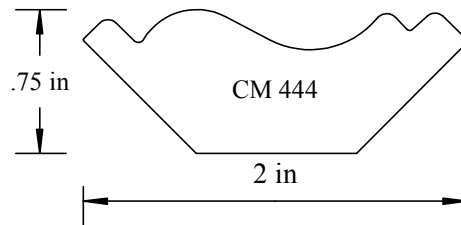
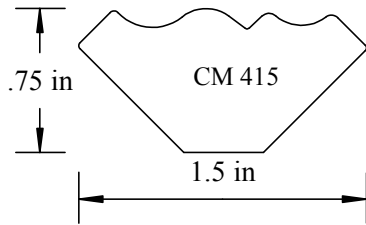
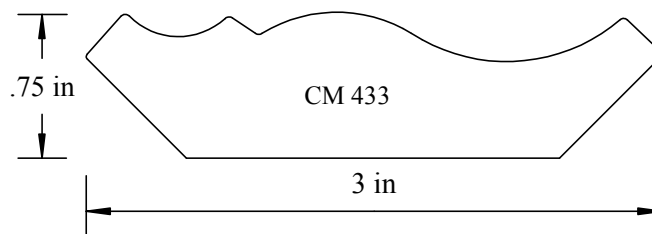
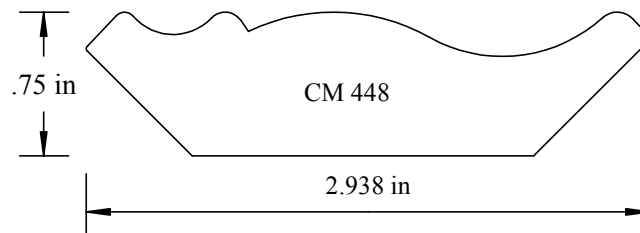
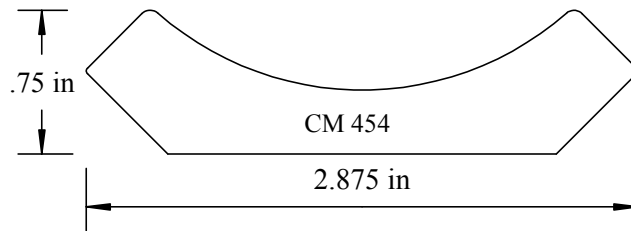
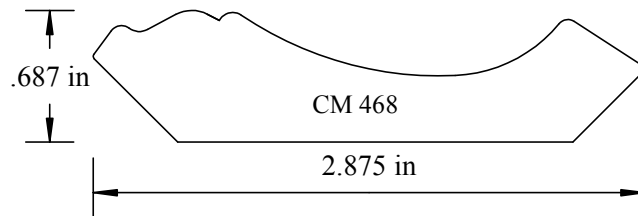
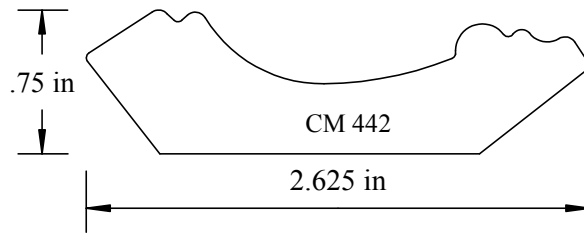

Molding Profiles - Crowns

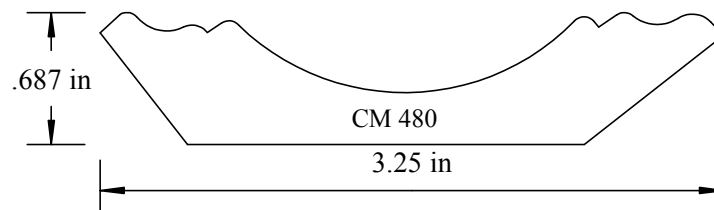
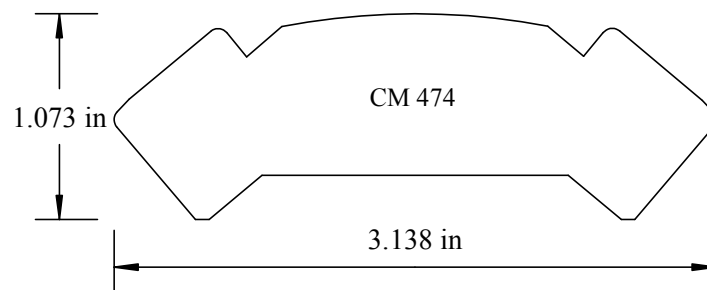
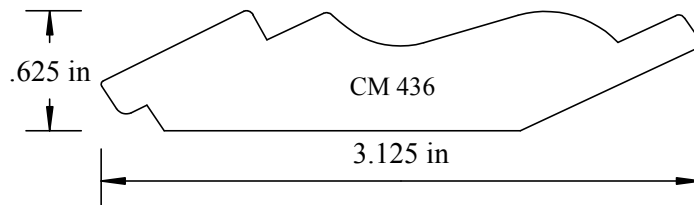
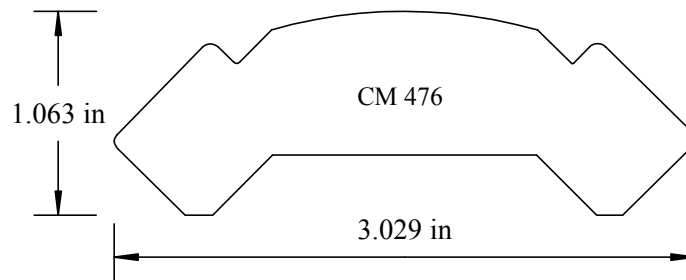
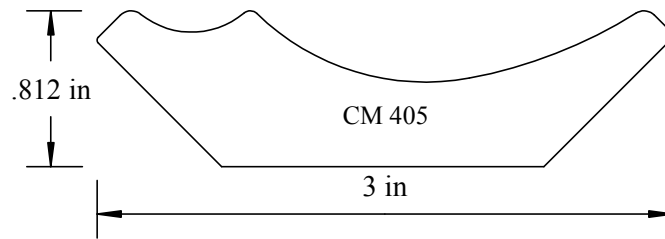

Molding Profiles - Crowns

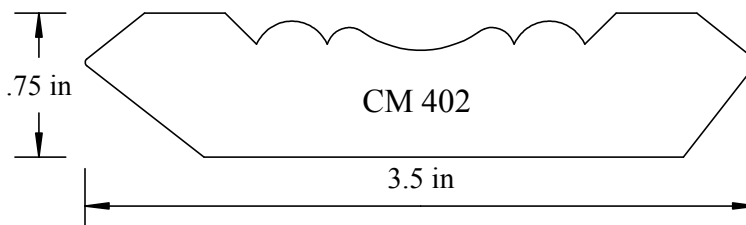
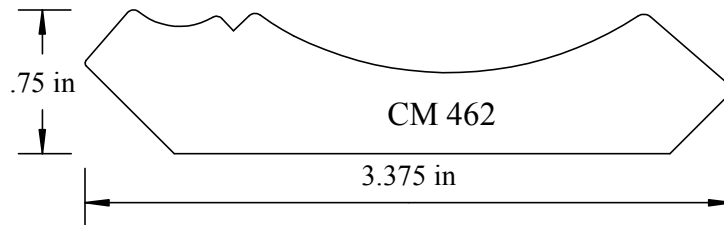
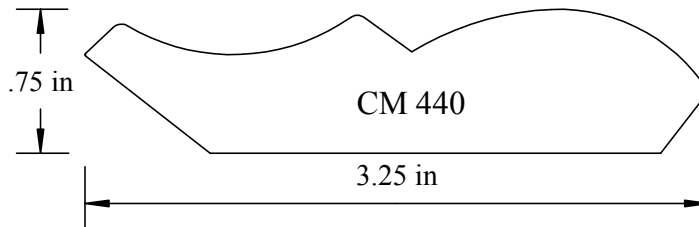
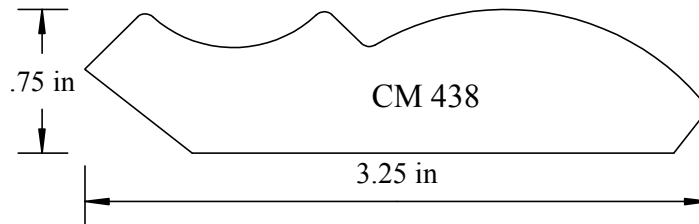
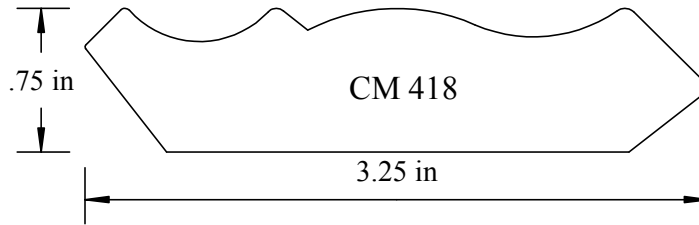

Molding Profiles - Crowns

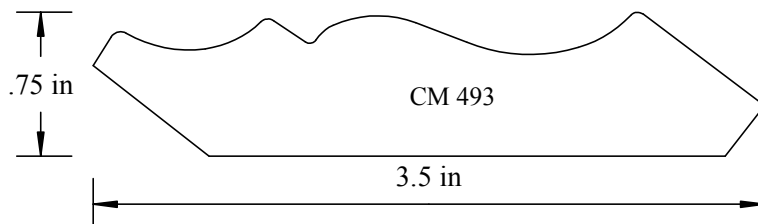
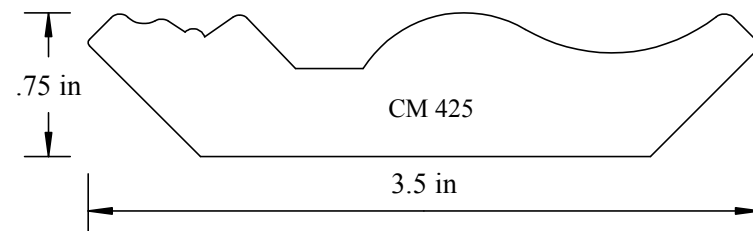
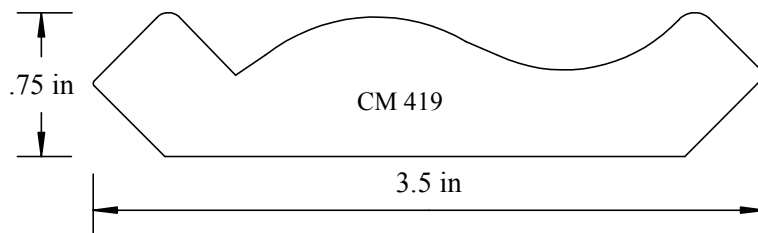
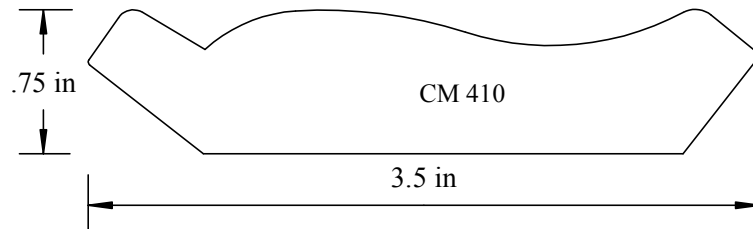
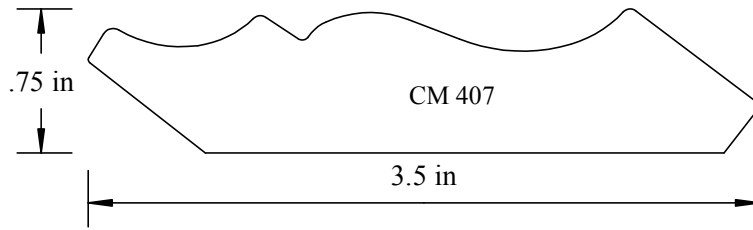

Molding Profiles - Crowns

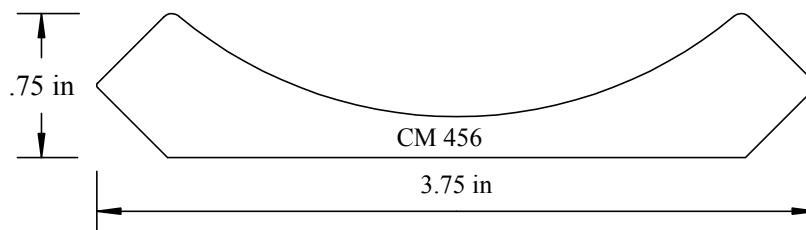
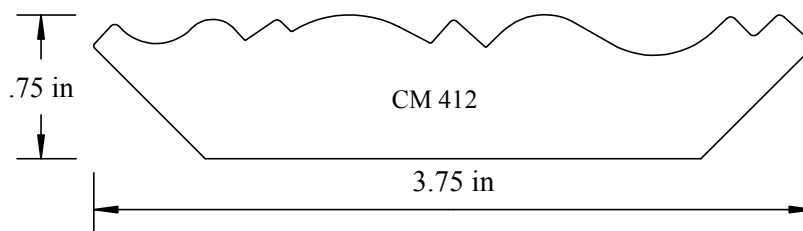
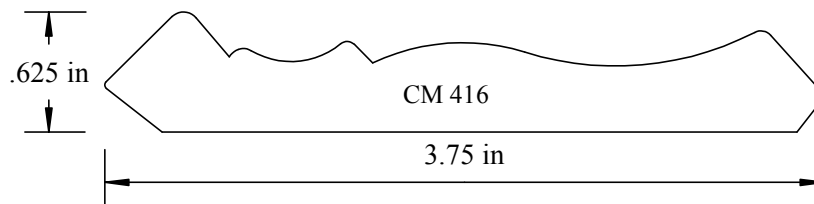
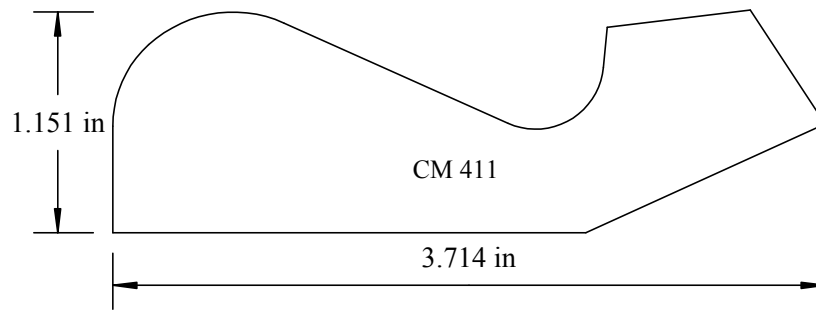
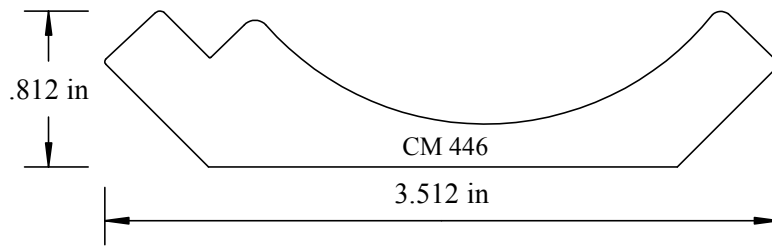

Molding Profiles - Crowns

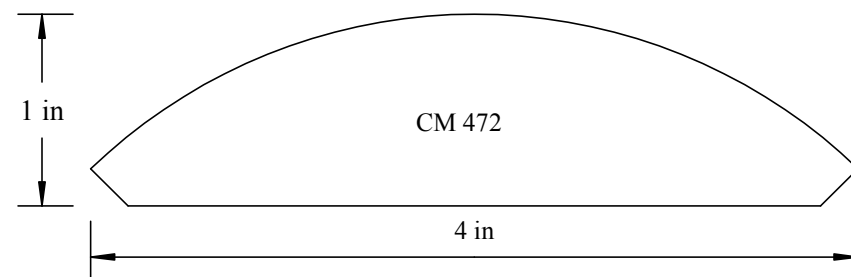
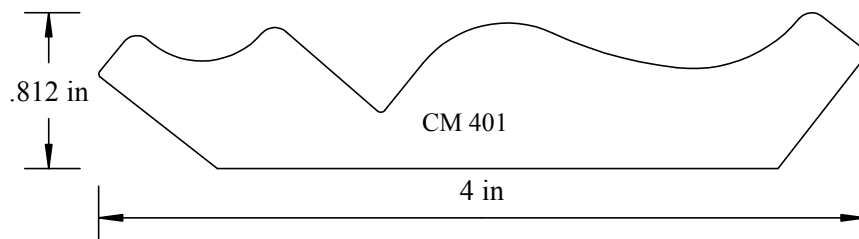
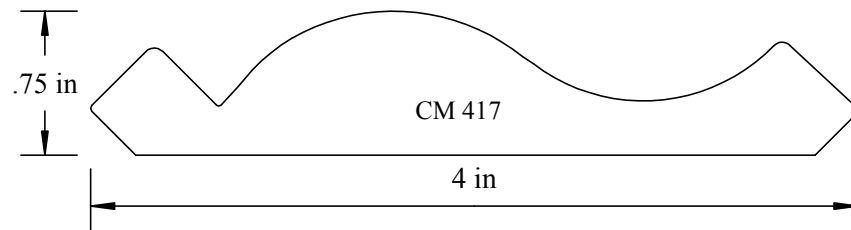
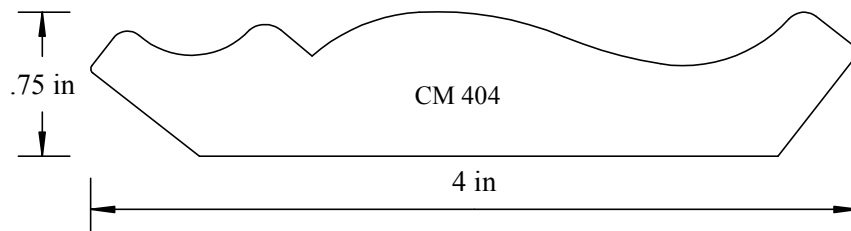
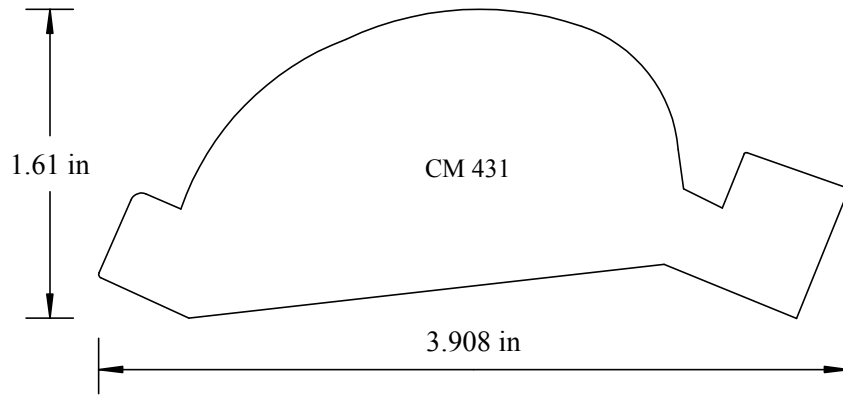

Molding Profiles - Crowns

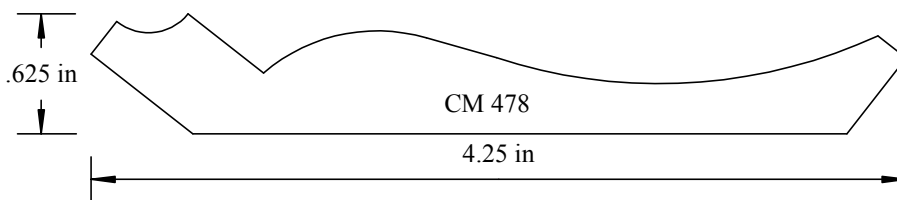
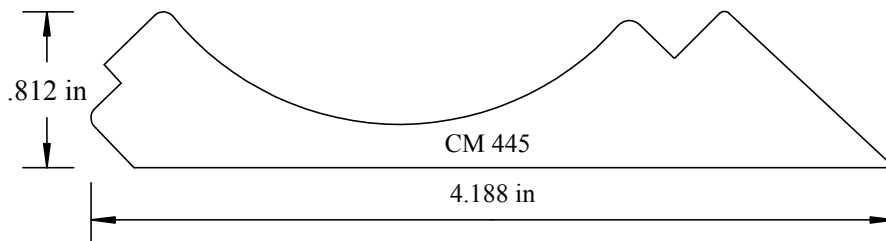
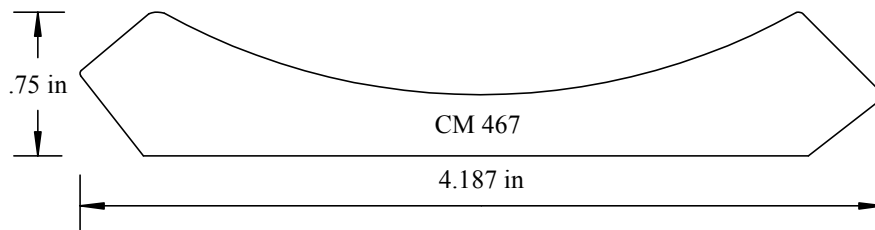
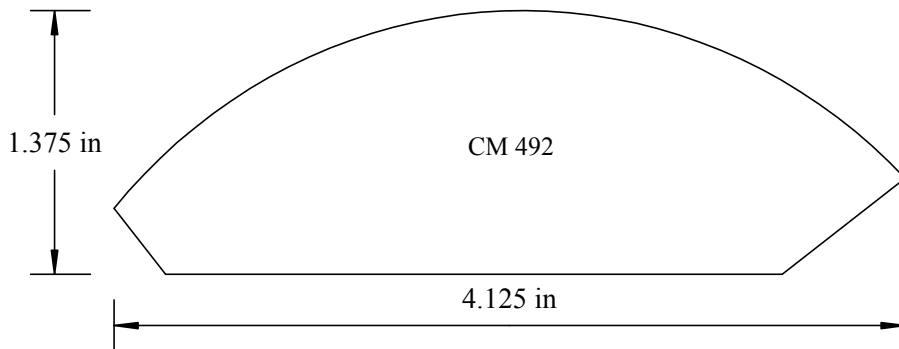
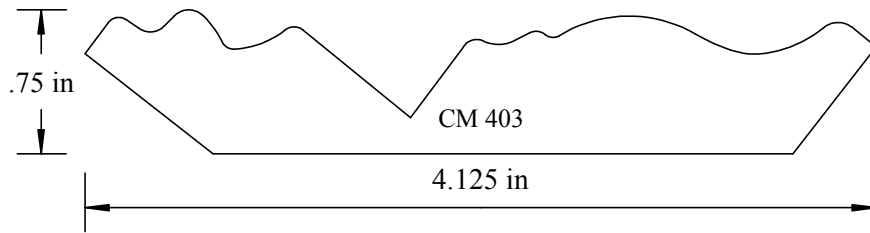

Molding Profiles - Crowns

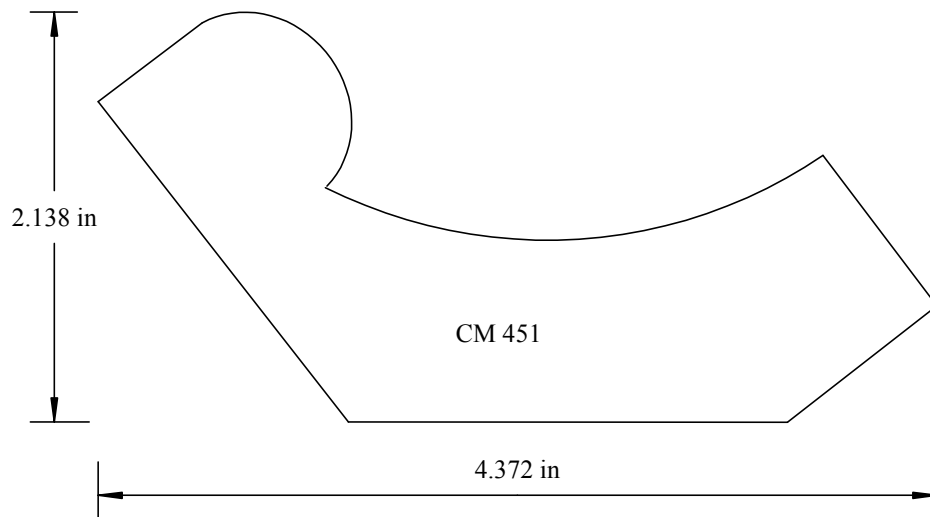
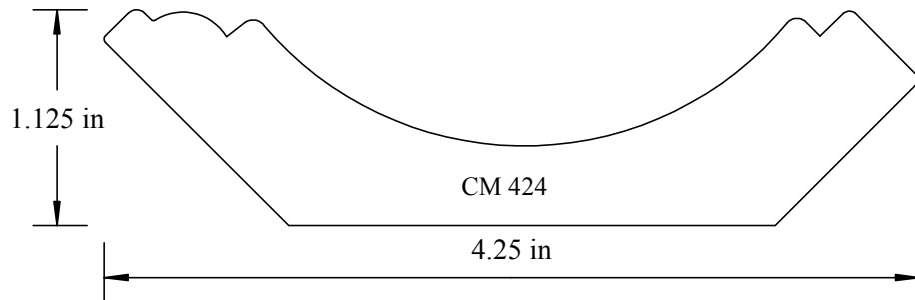
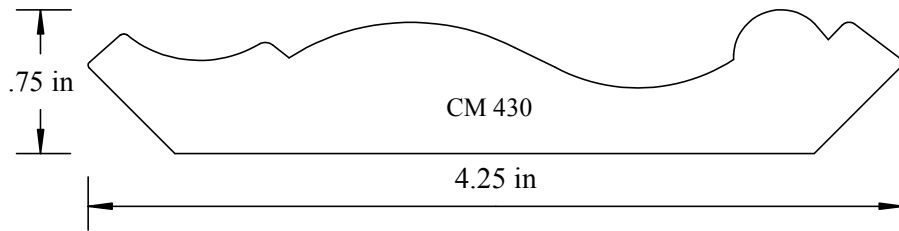
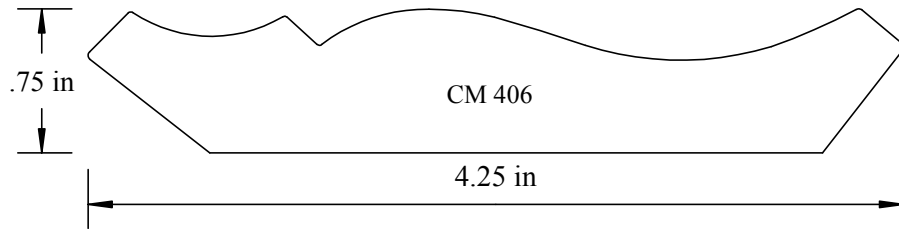

Molding Profiles - Crowns

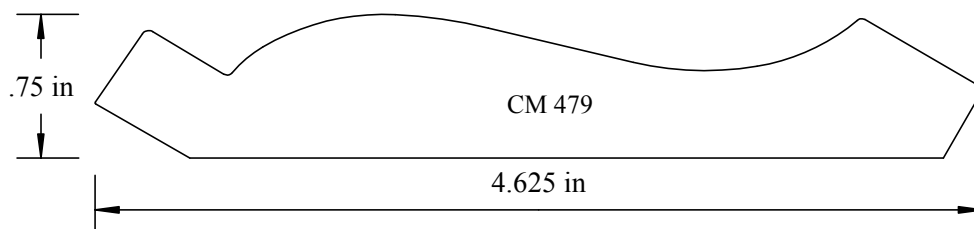
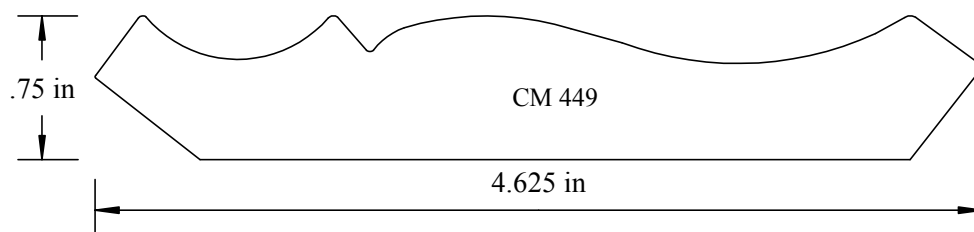
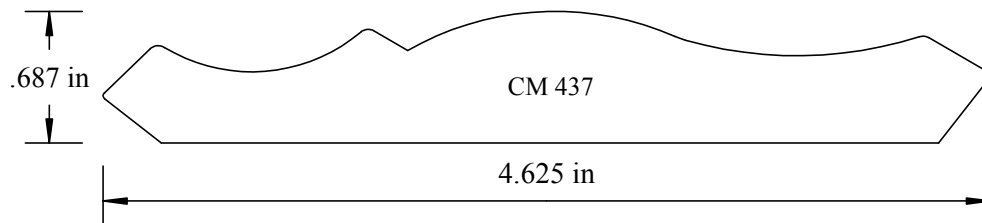
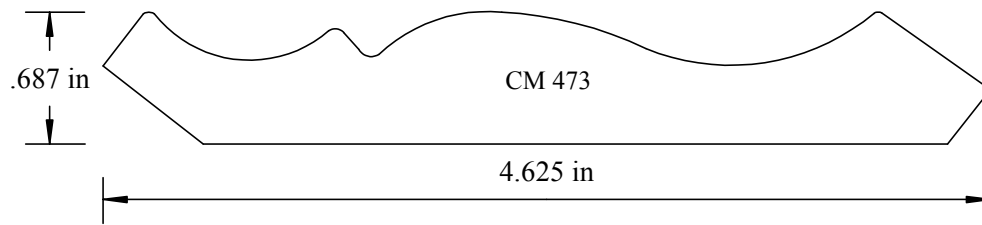
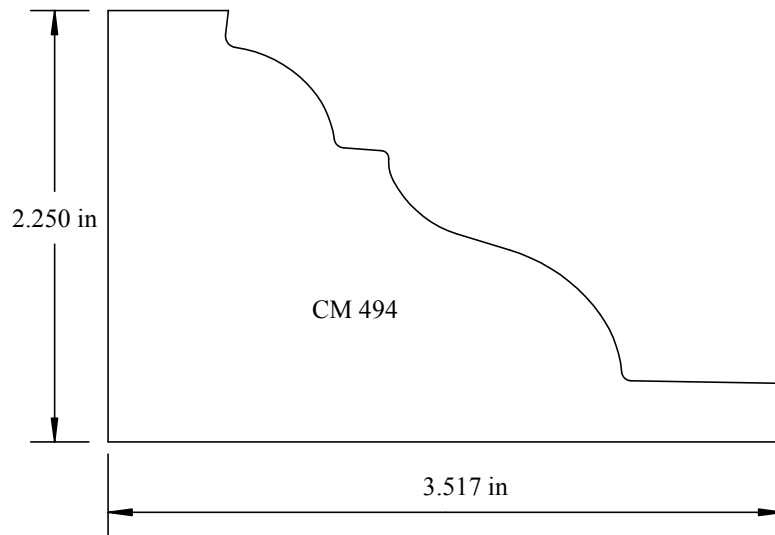

Molding Profiles - Crowns

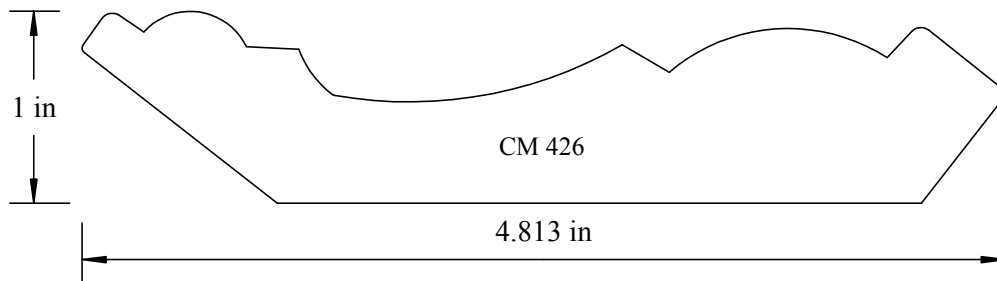
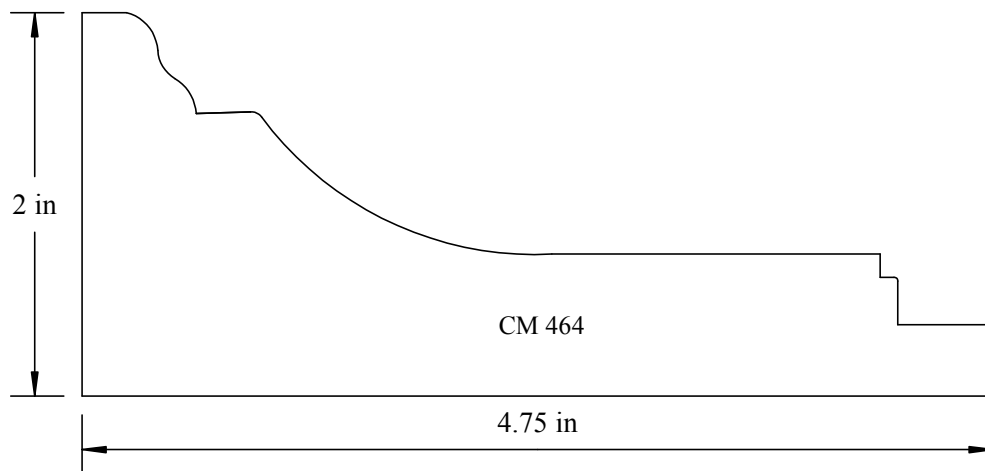
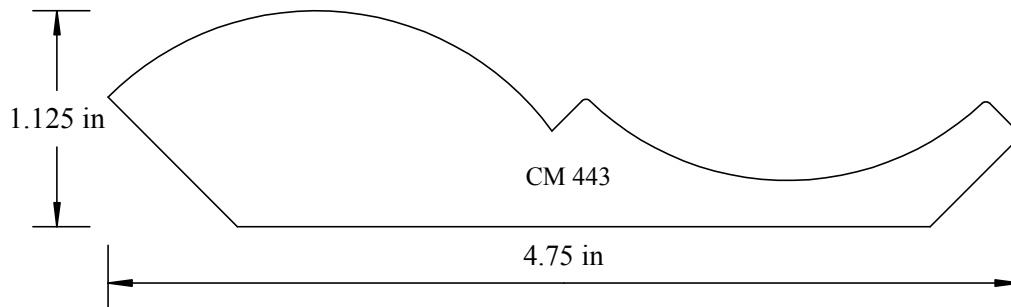
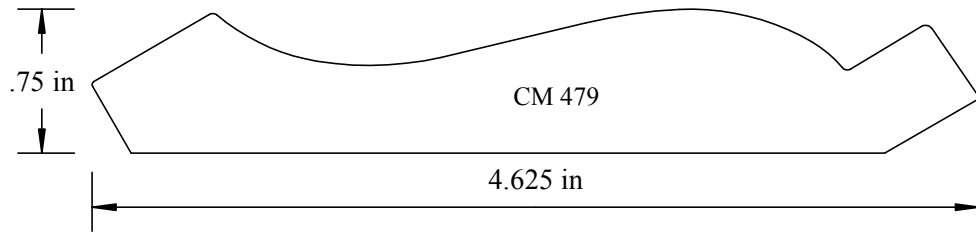

Molding Profiles - Crowns

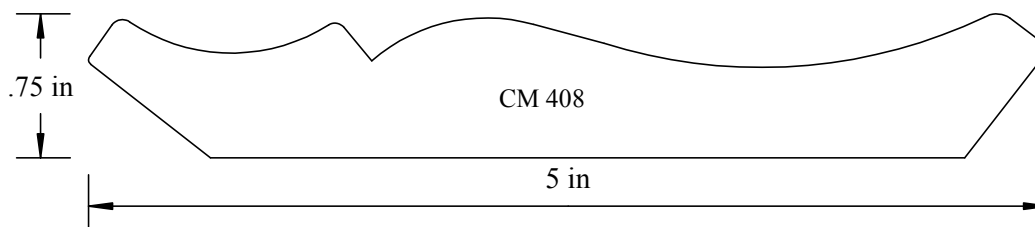
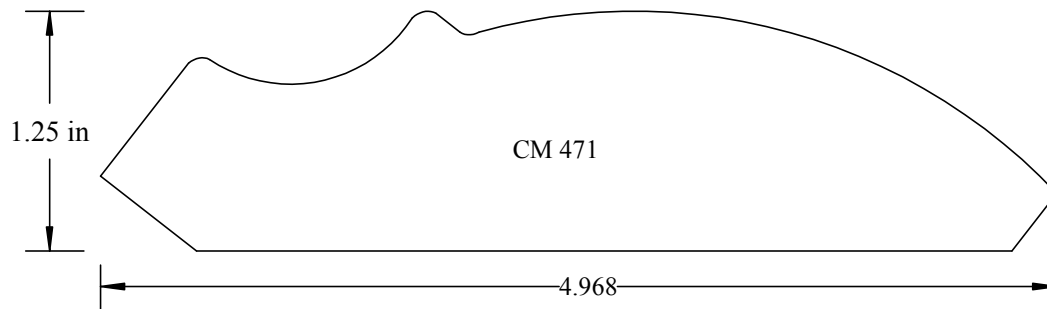
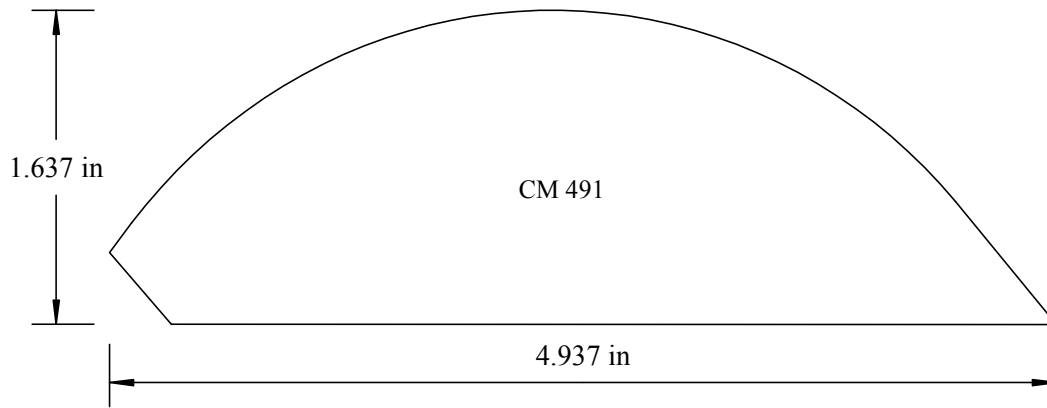
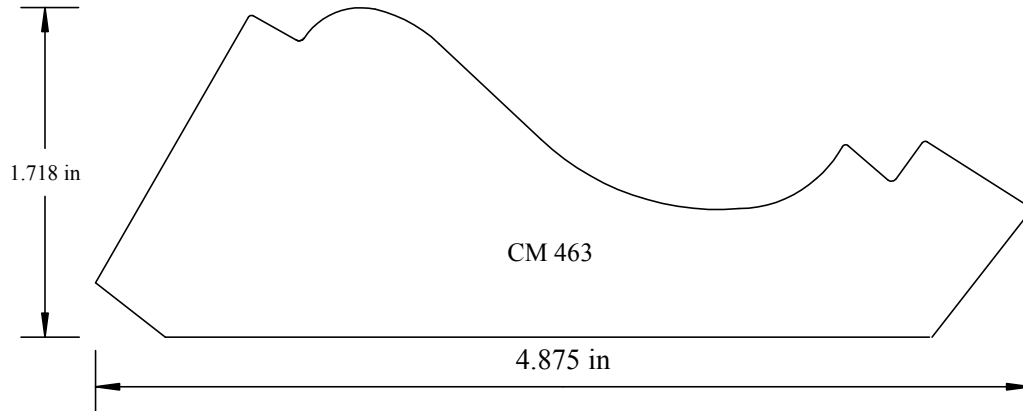

Molding Profiles - Crowns

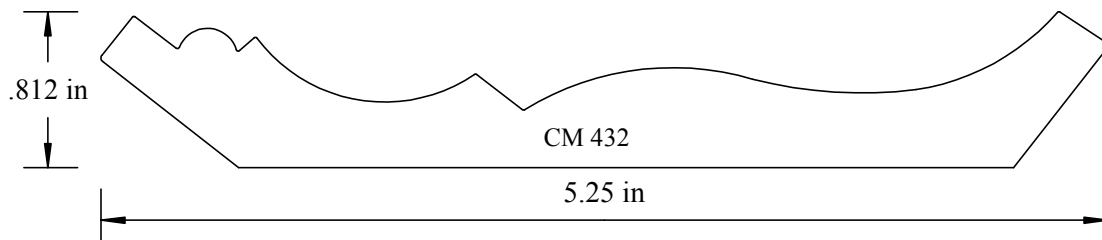
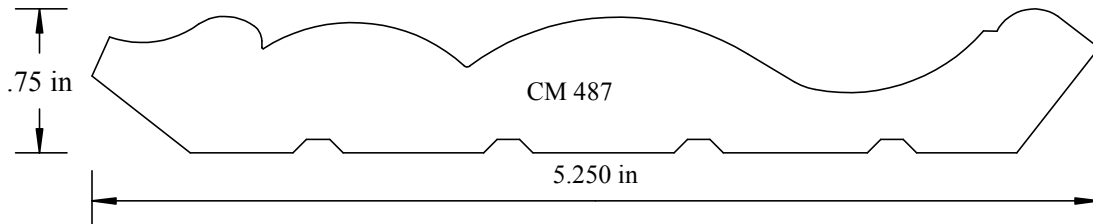
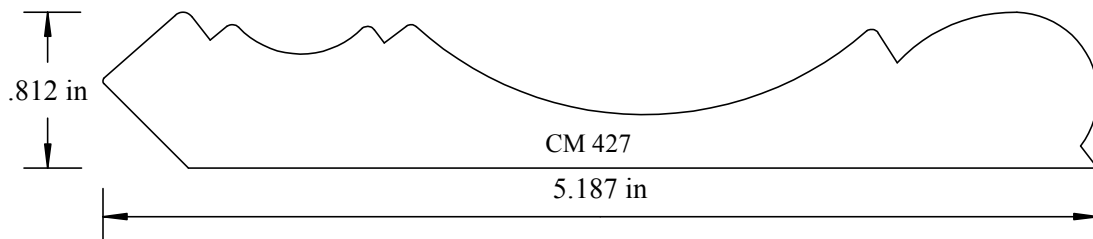
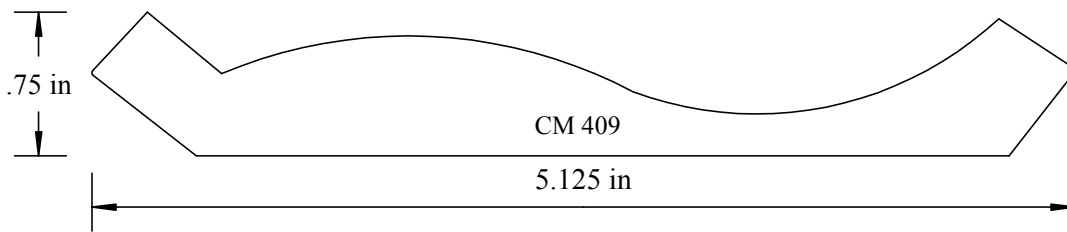
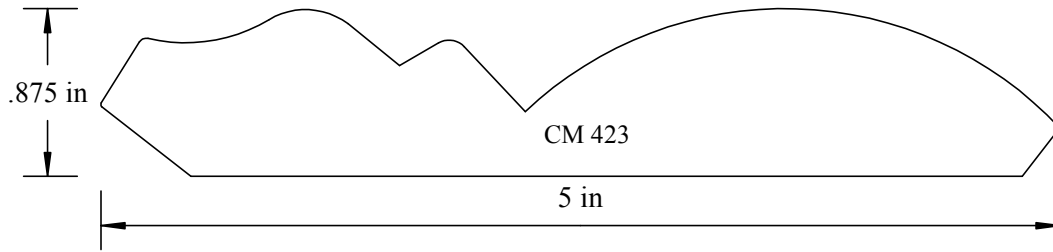

Molding Profiles - Crowns

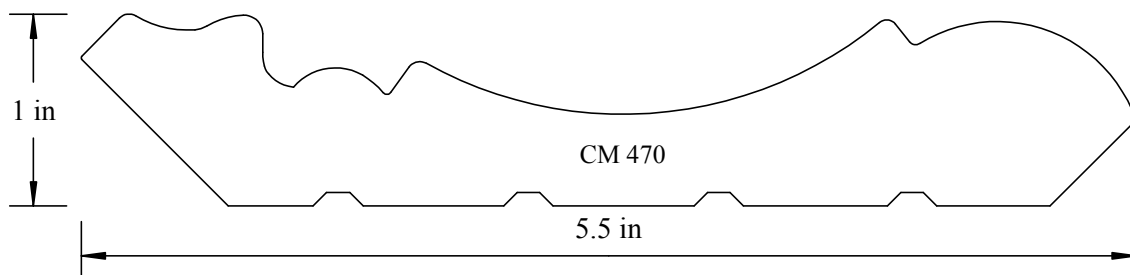
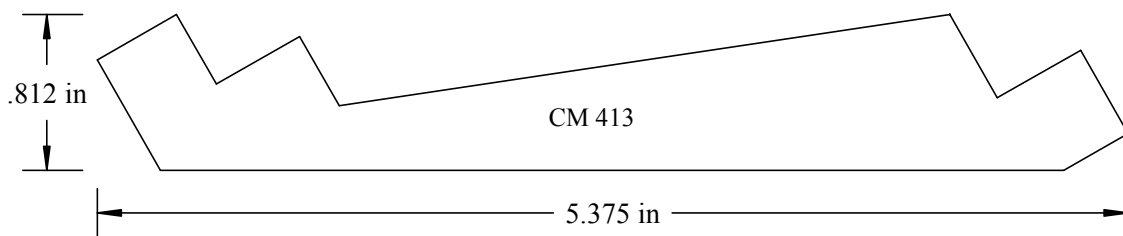
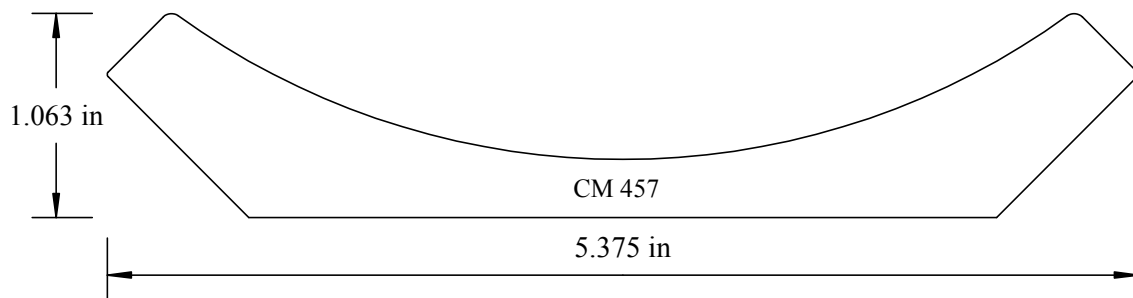
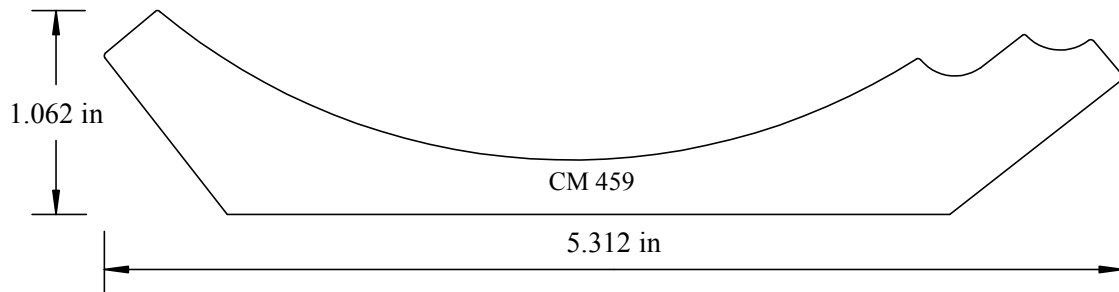
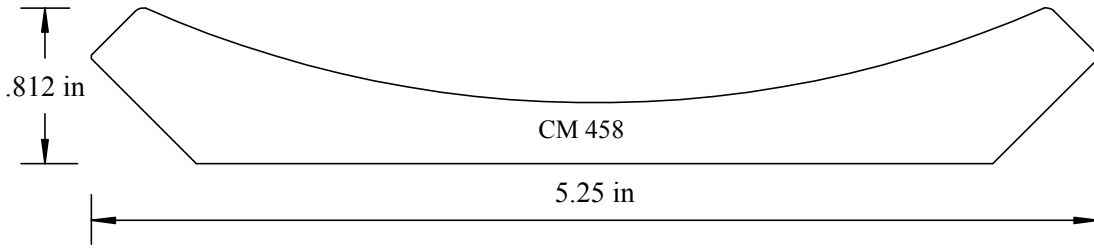

Molding Profiles - Crowns

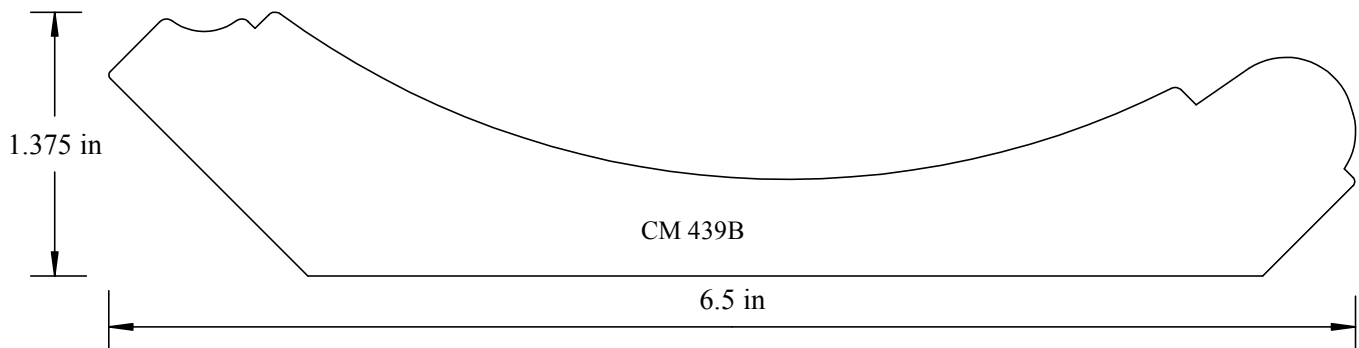
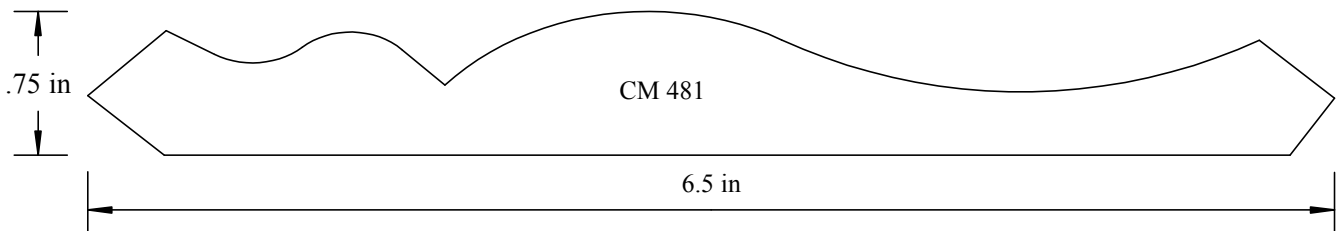
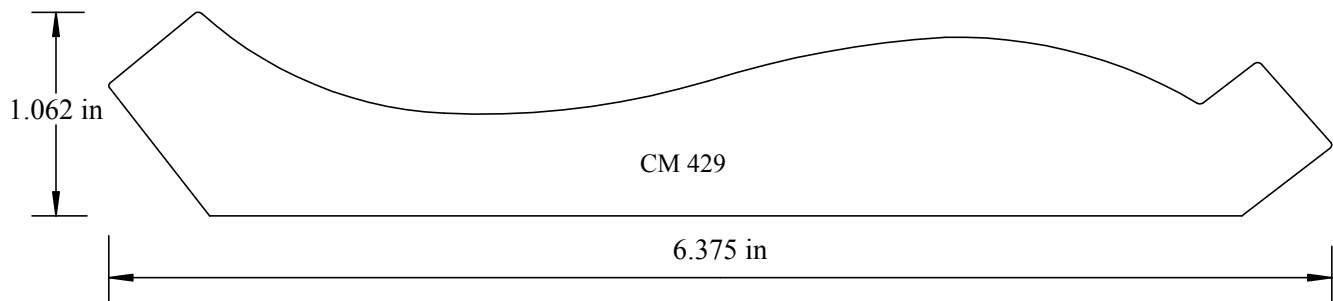
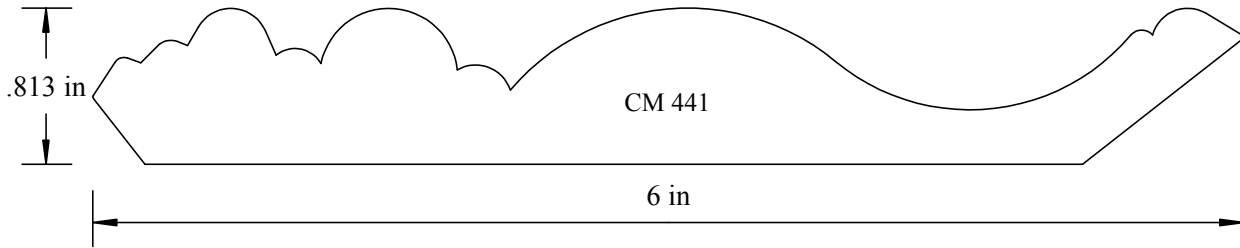
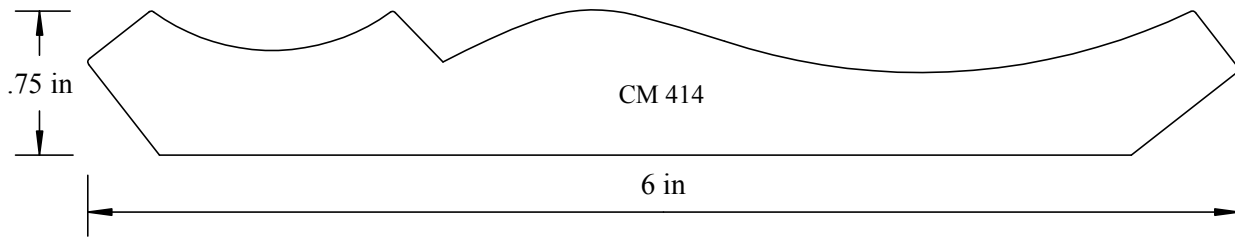

Molding Profiles - Crowns

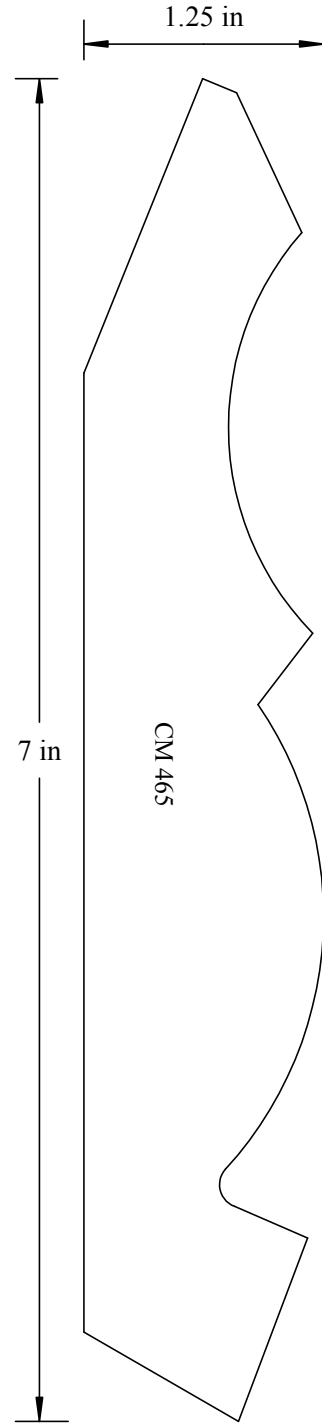
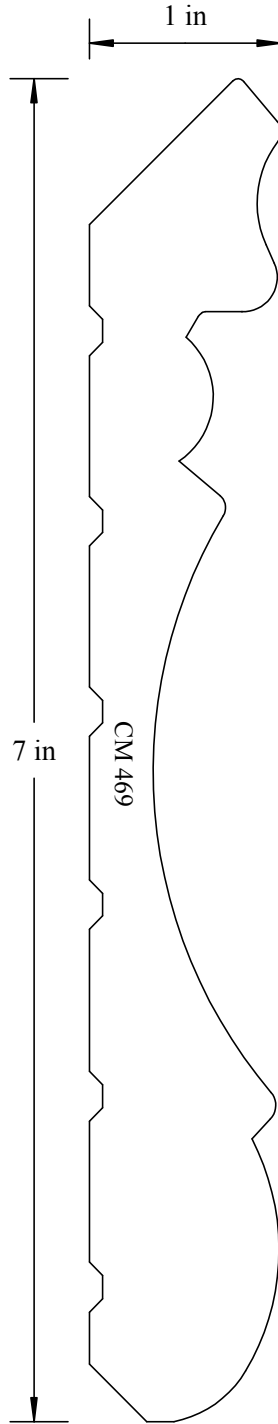
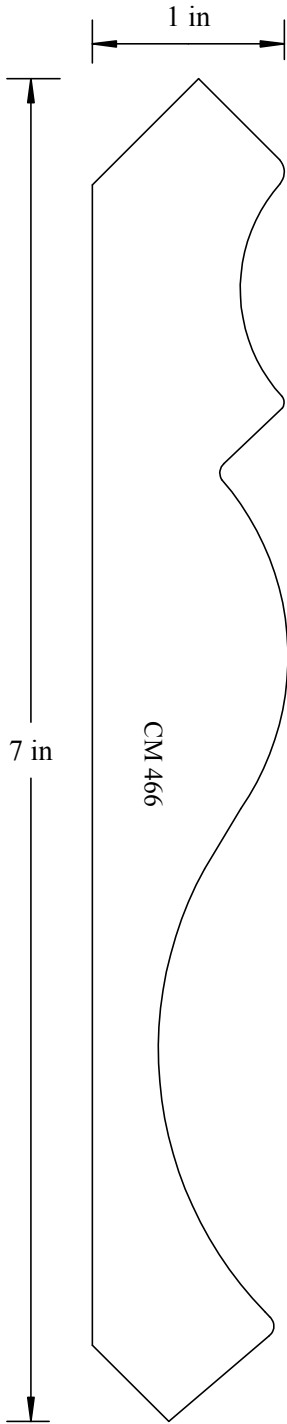

Molding Profiles - Crowns

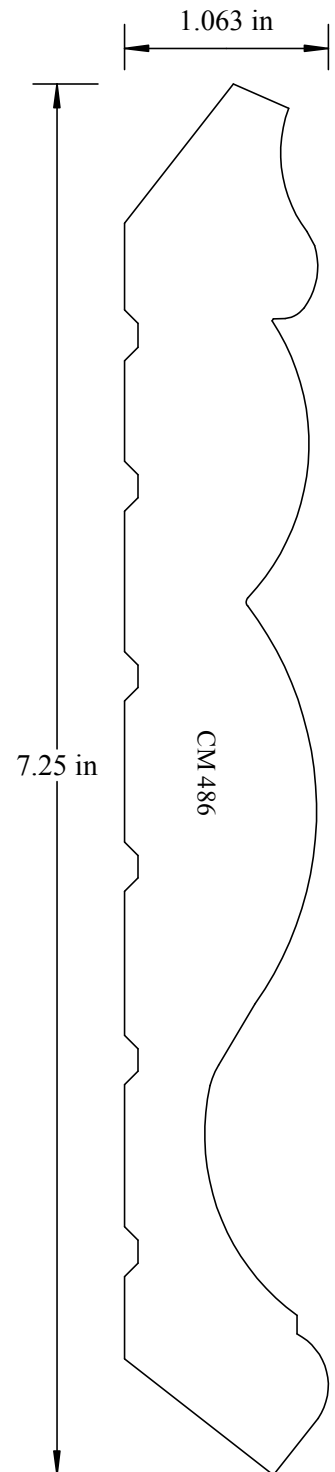
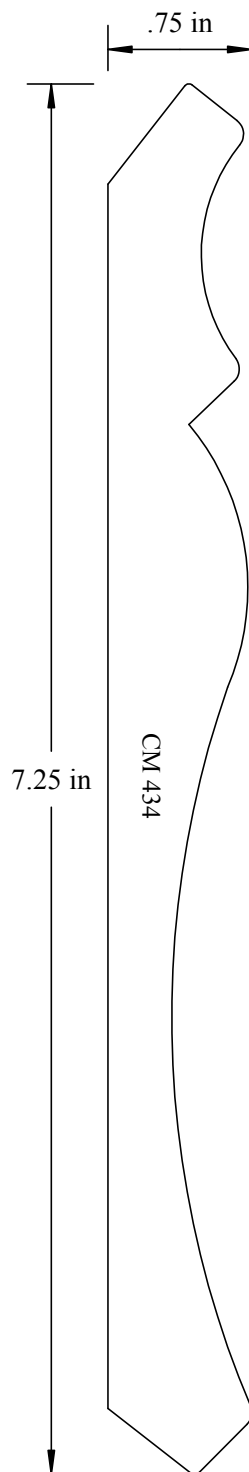
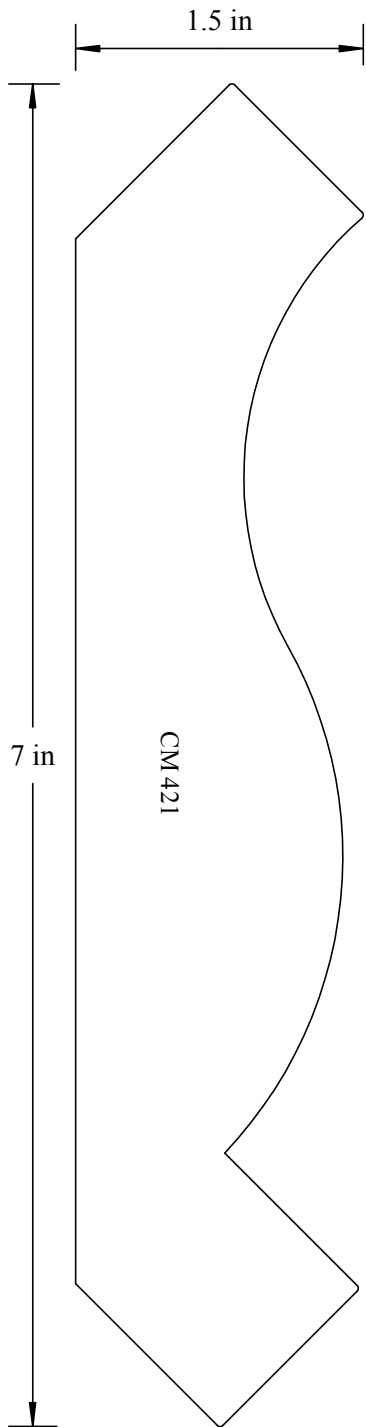

Molding Profiles - Crowns

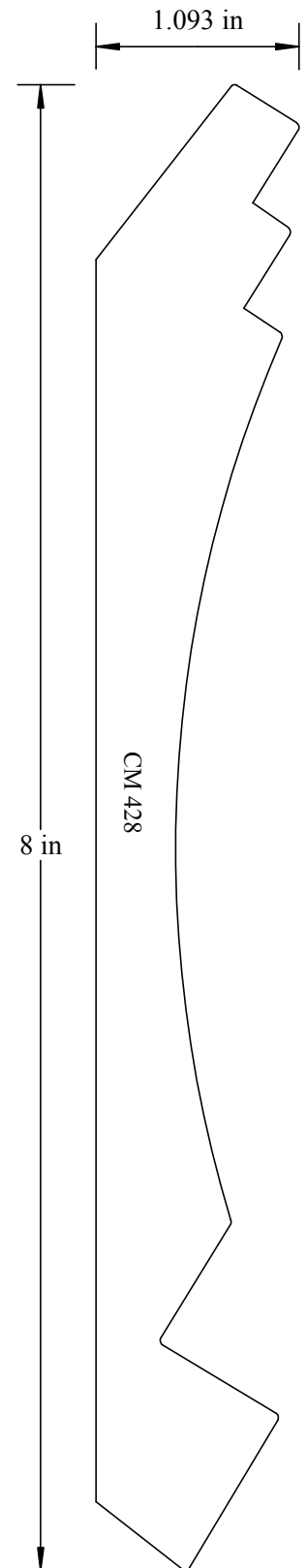
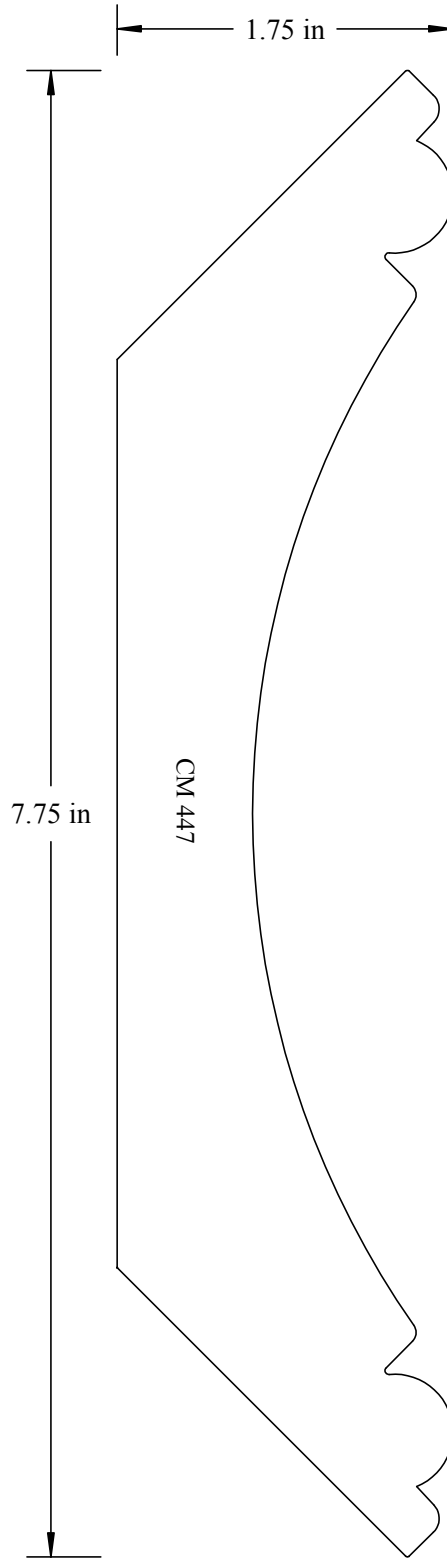
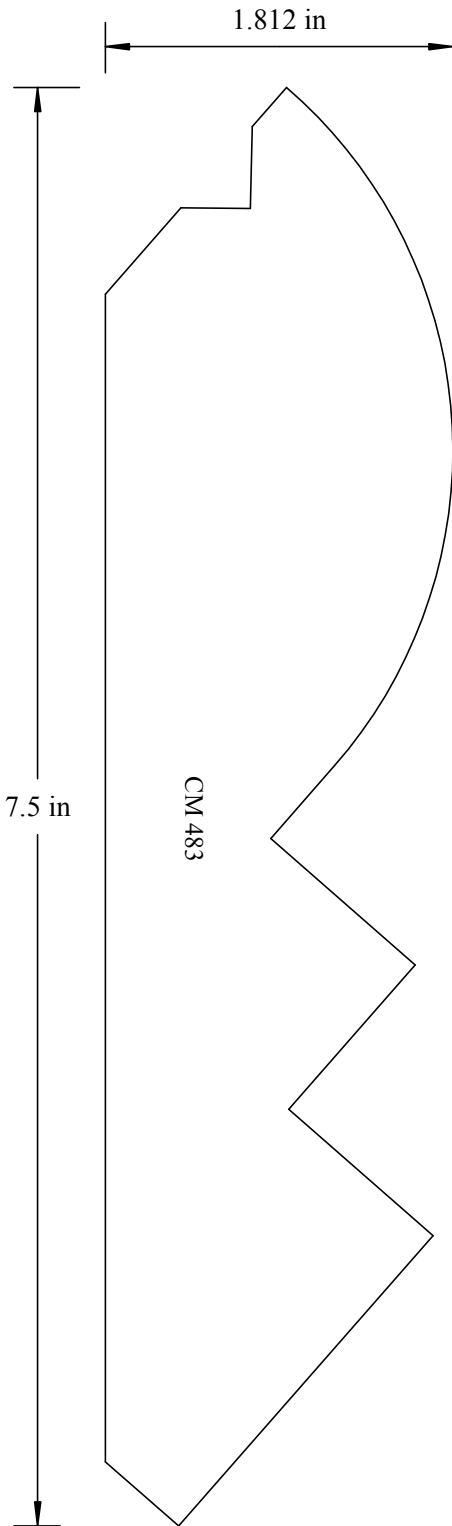

Molding Profiles - Crowns

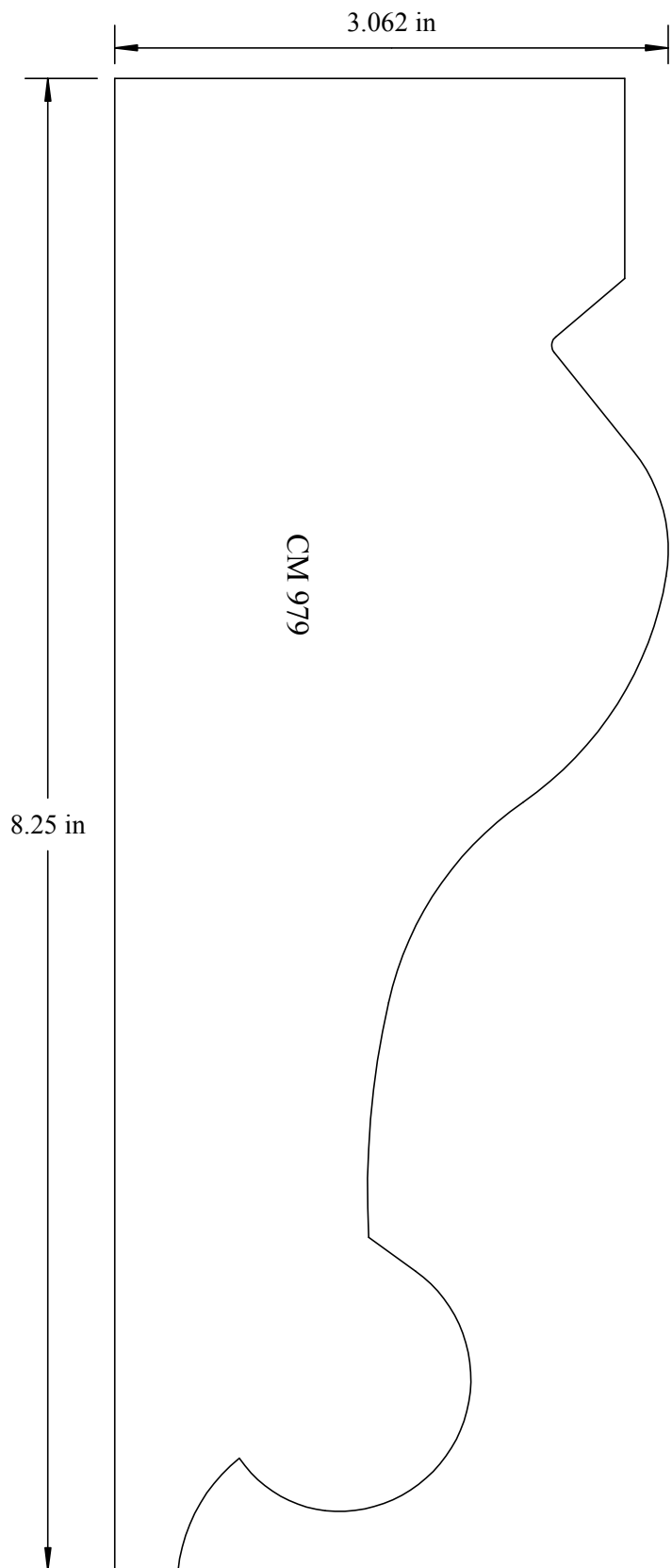
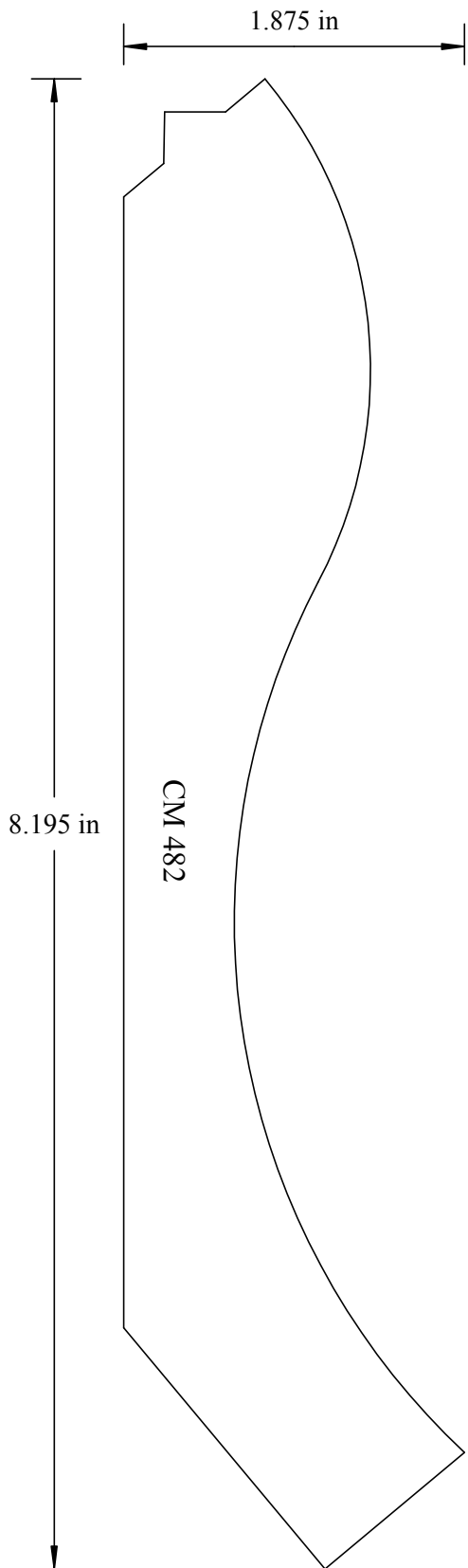

Molding Profiles - Crowns

