

Molding Profiles - Chair Rails

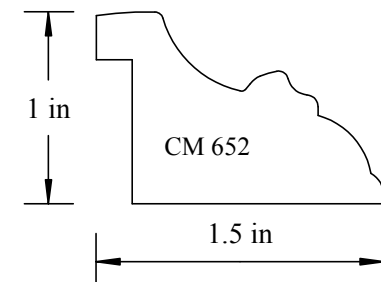

Molding Profiles - Chair Rails

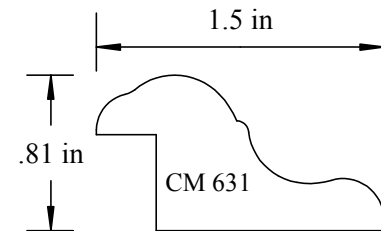
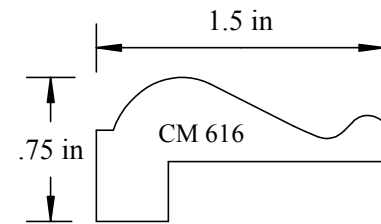
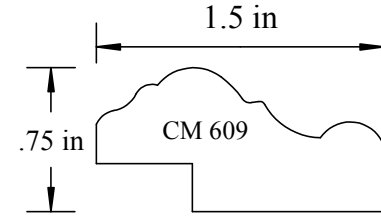
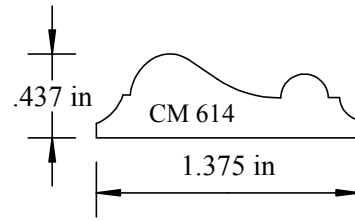
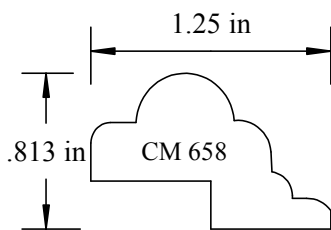
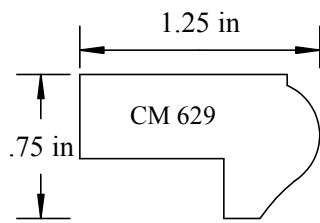
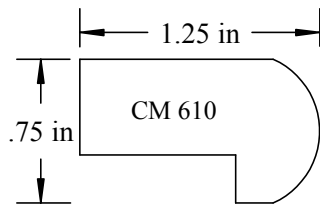
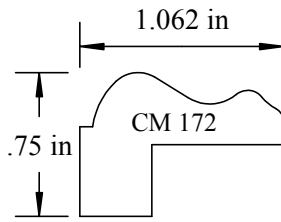
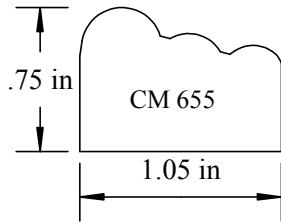
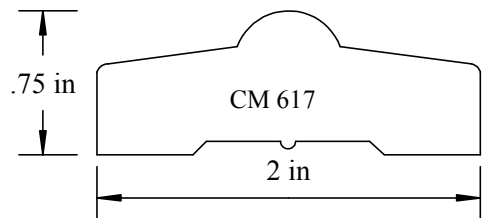
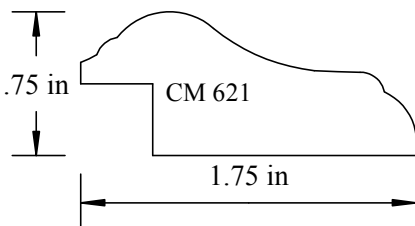
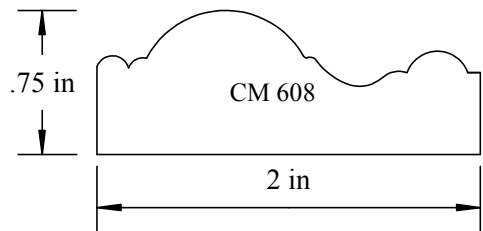
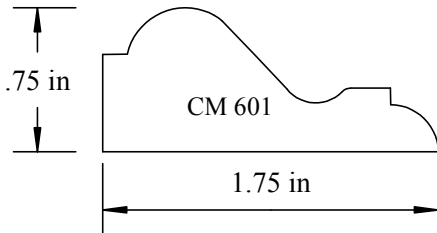
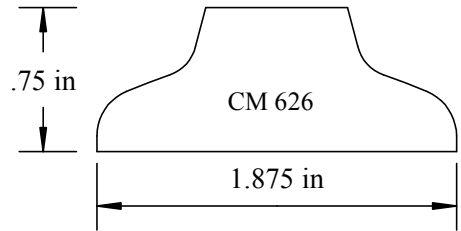
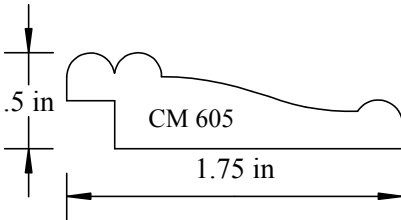
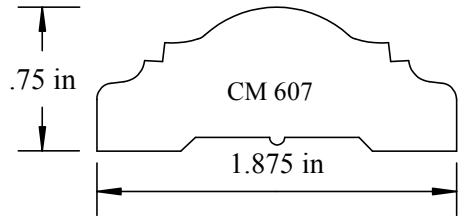
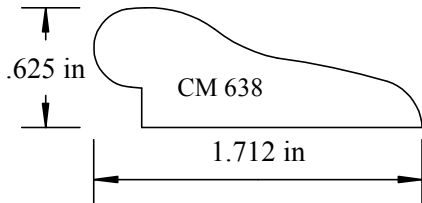
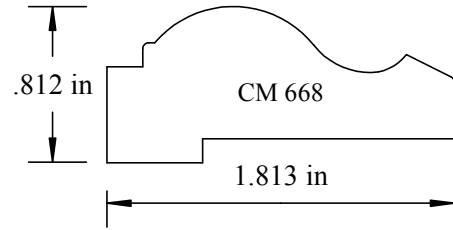
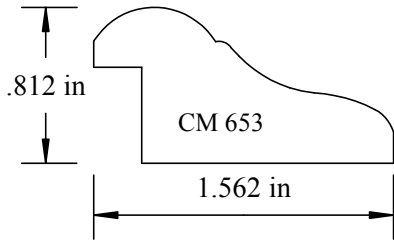

Molding Profiles - Chair Rails

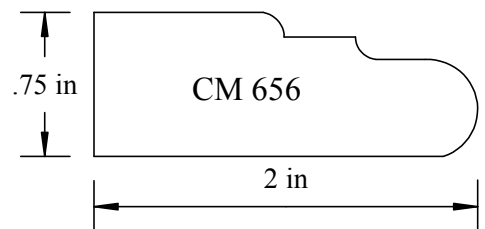
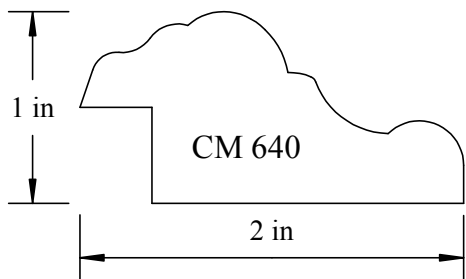
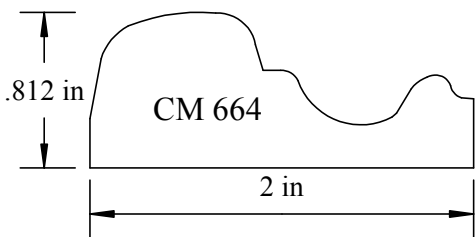
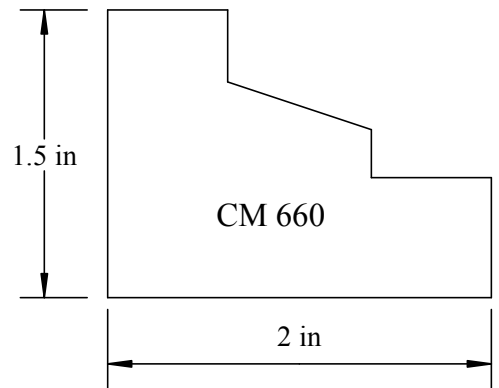
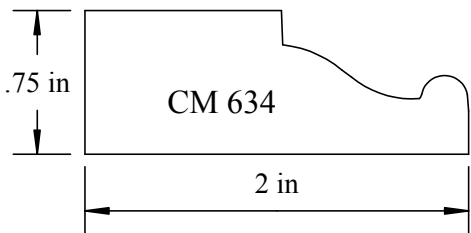
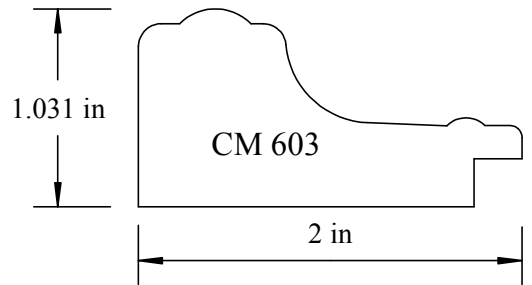
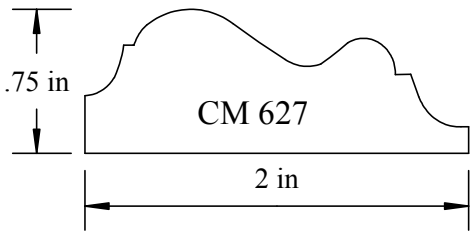
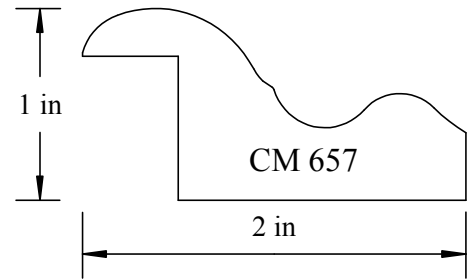
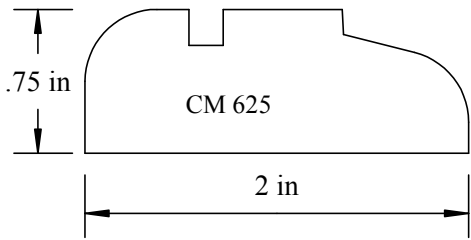

Molding Profiles - Chair Rails

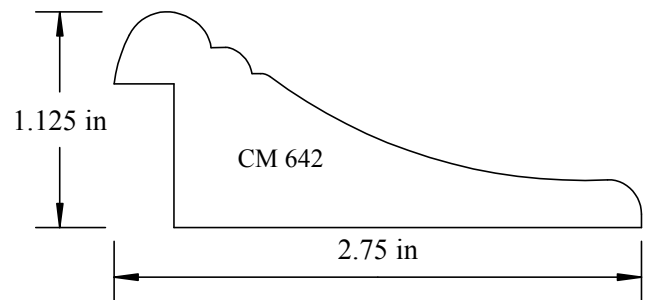
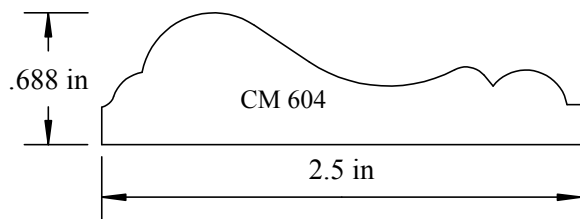
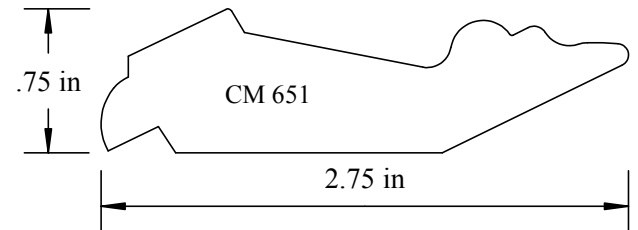
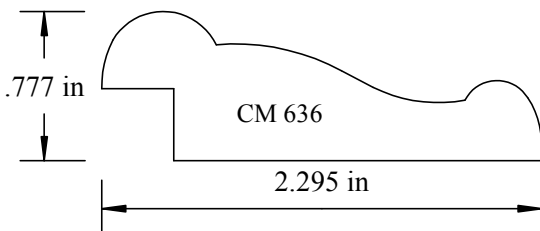
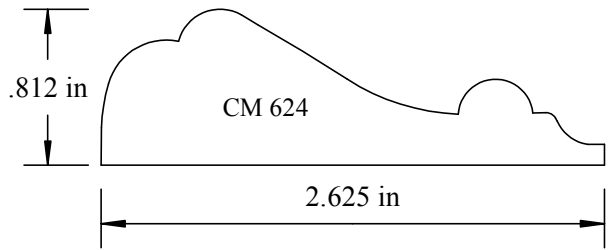
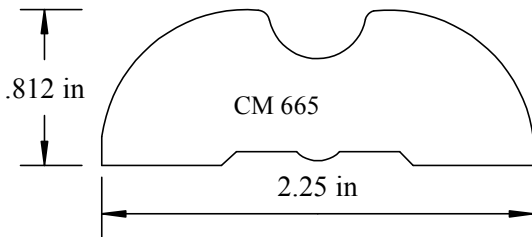
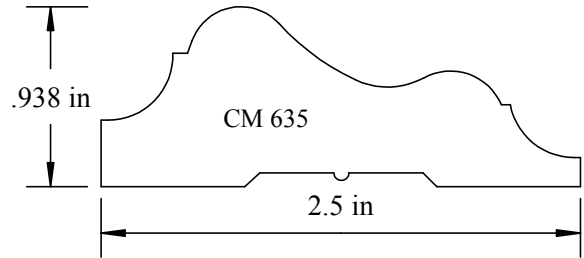
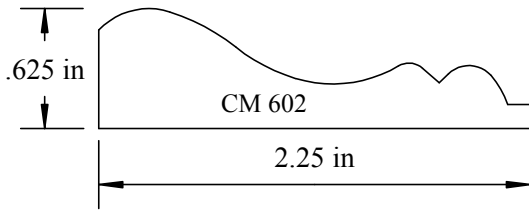
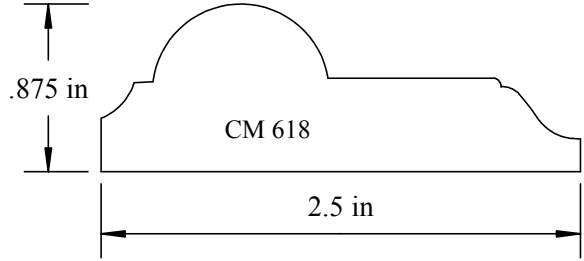
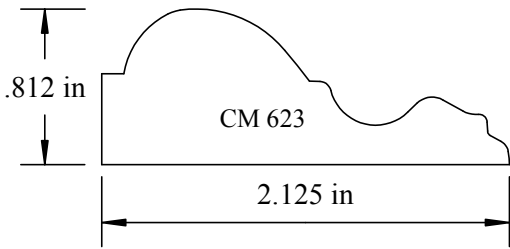

Molding Profiles - Chair Rails

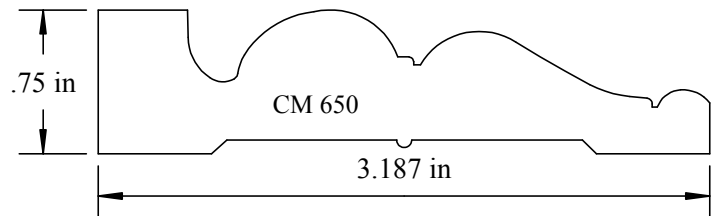
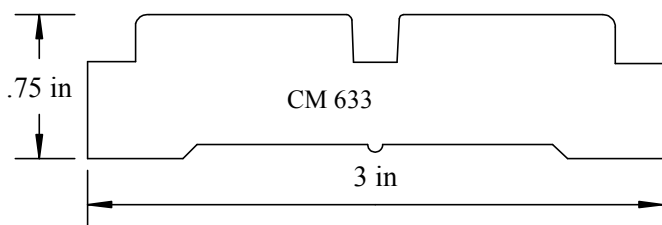
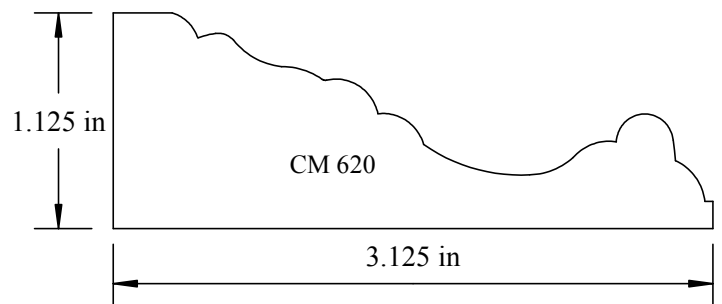
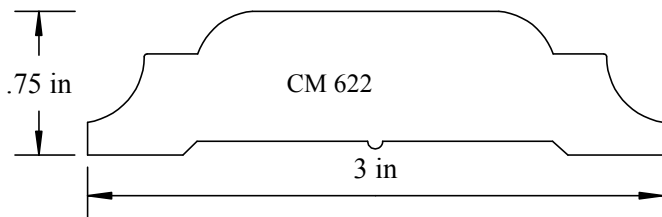
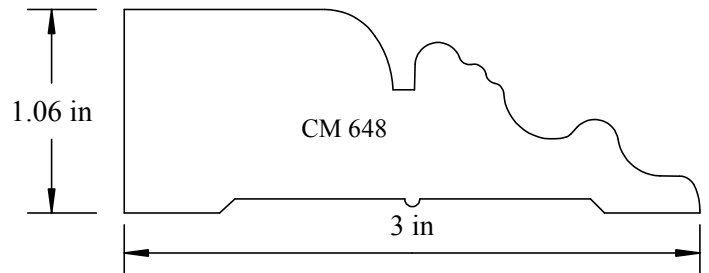
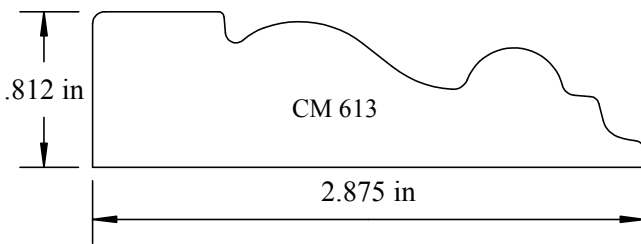
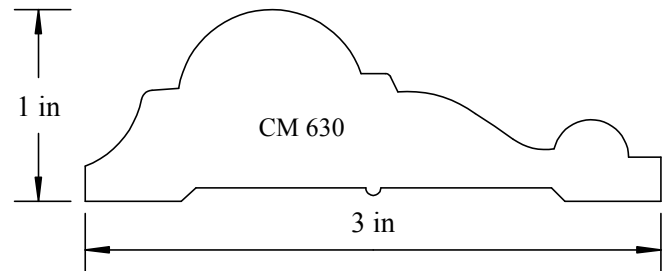
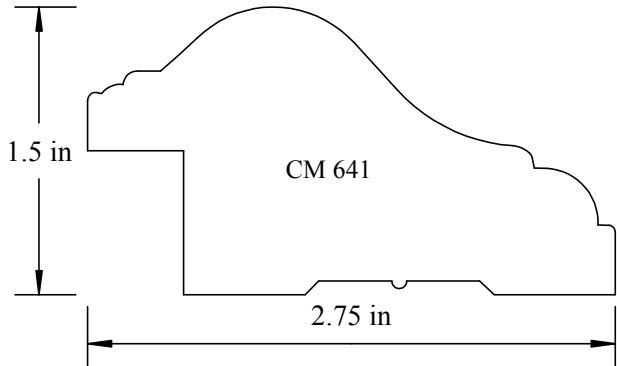
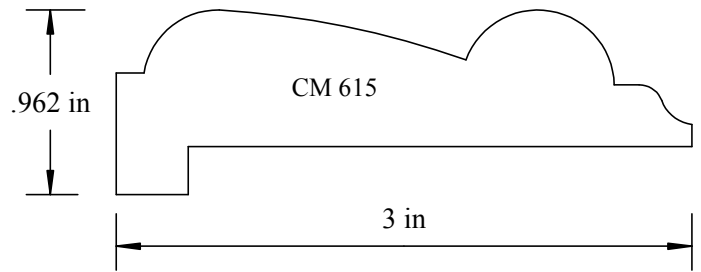
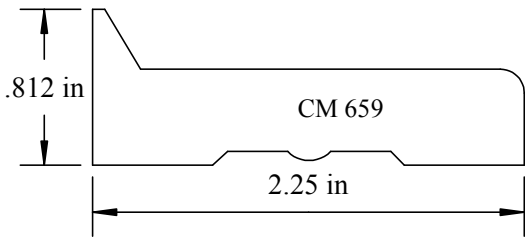

Molding Profiles - Chair Rails

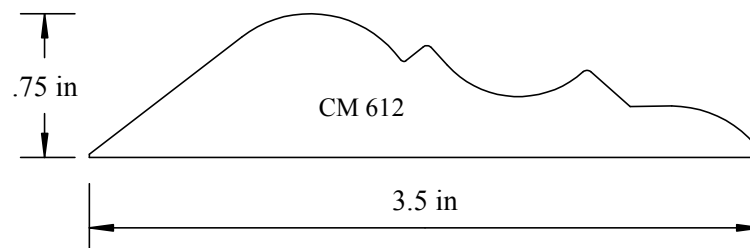
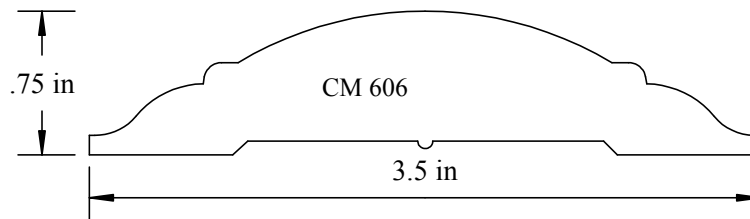
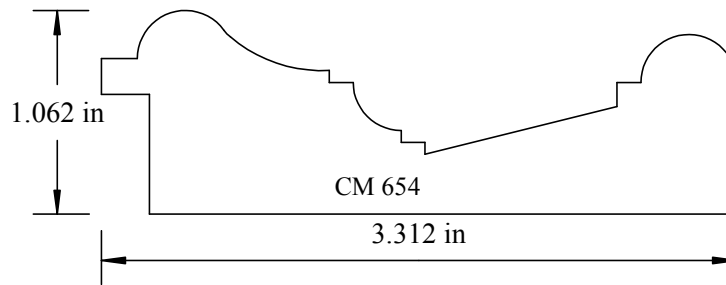
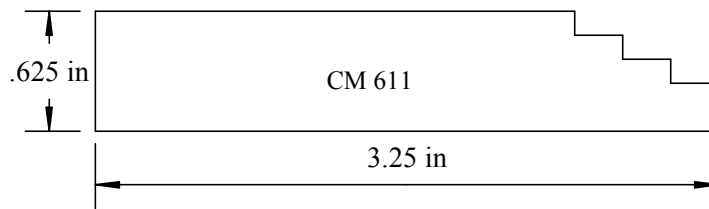
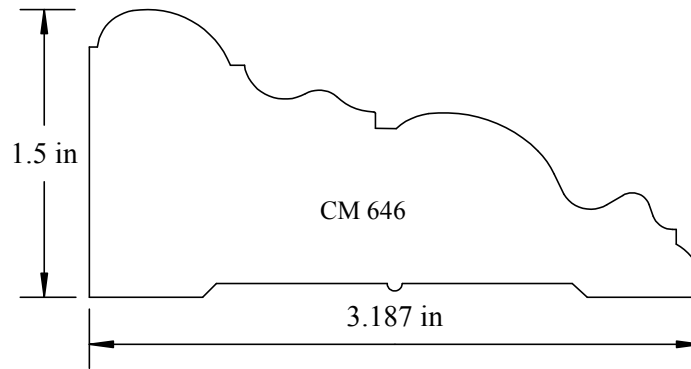

Molding Profiles - Chair Rails

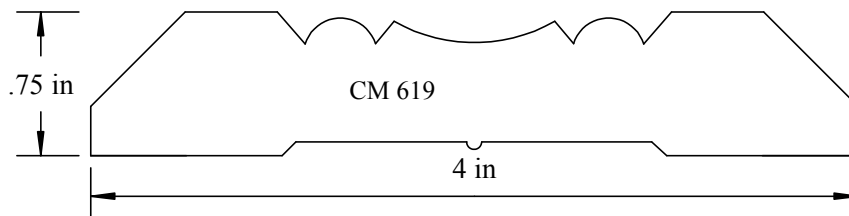
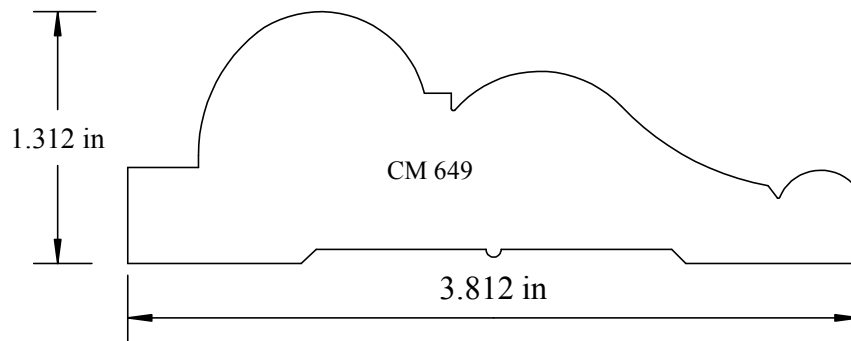
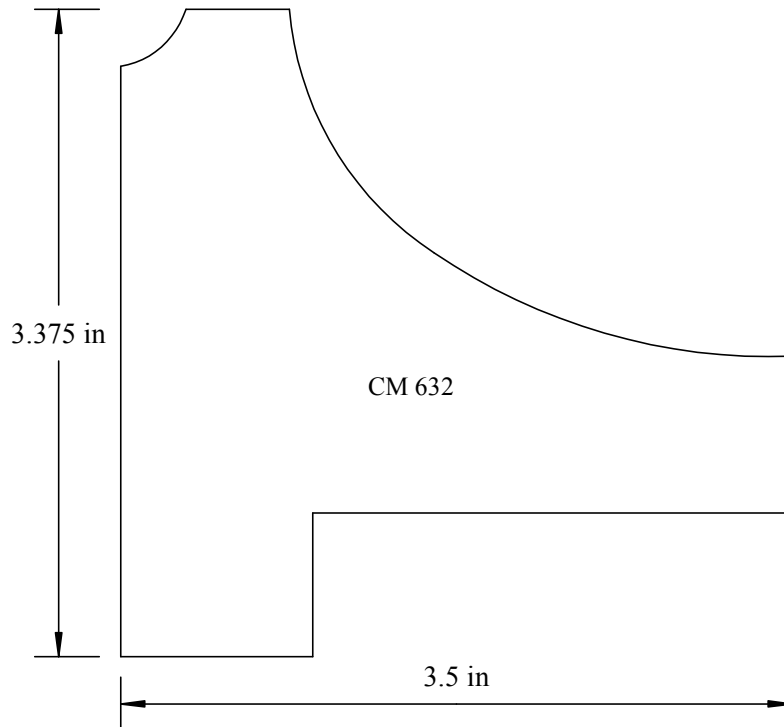

Molding Profiles - Chair Rails

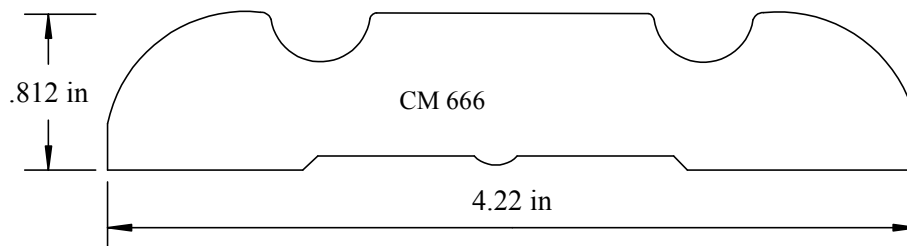
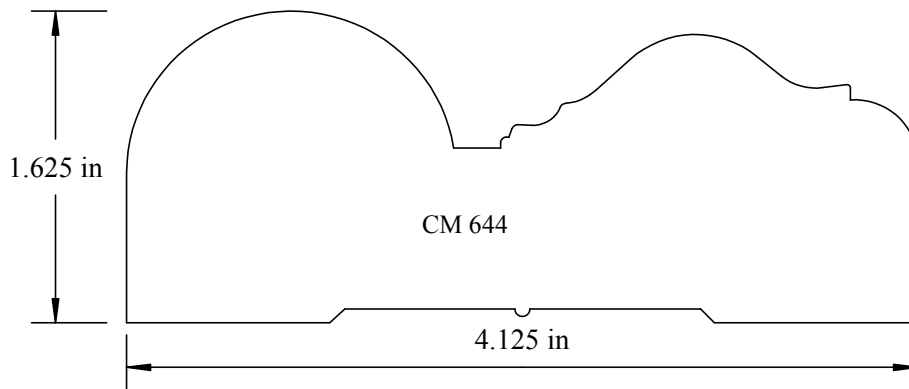
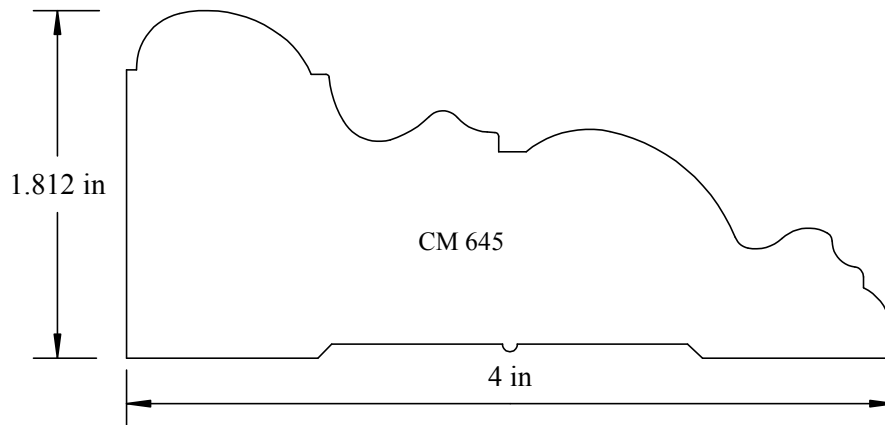
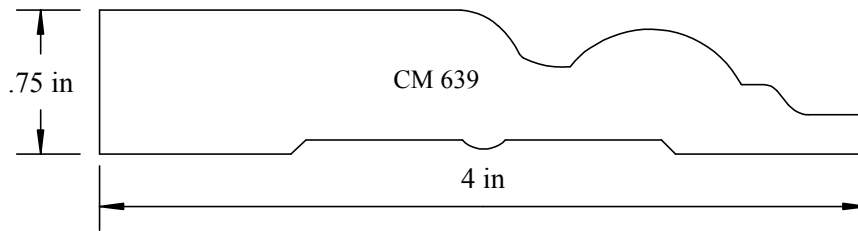

Molding Profiles - Chair Rails

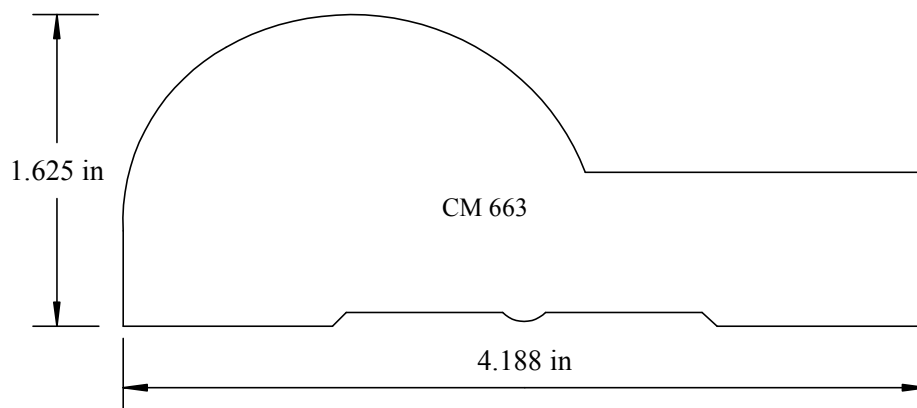
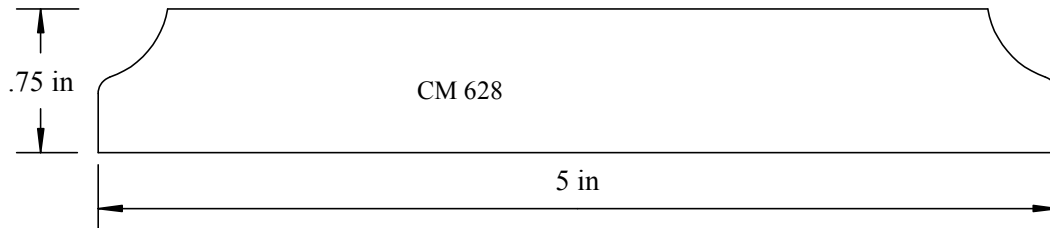
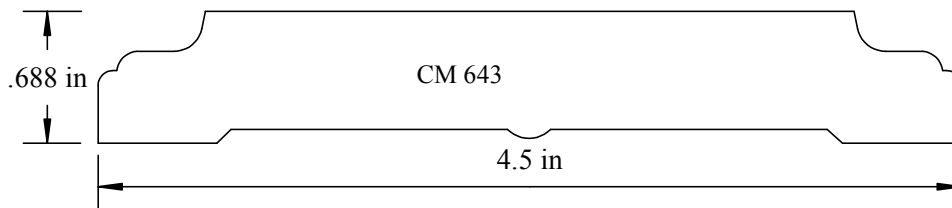
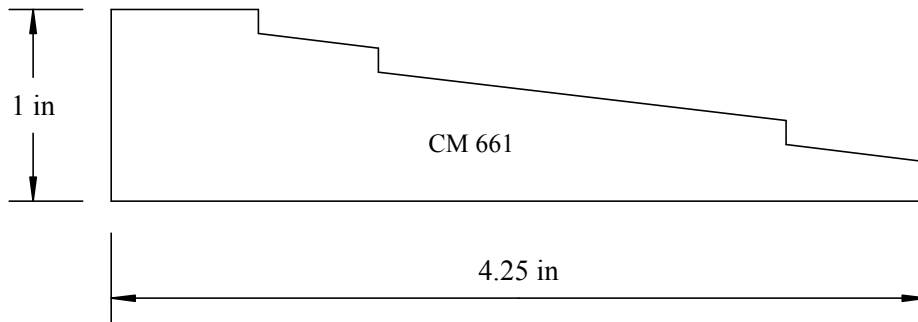

Molding Profiles - Chair Rails

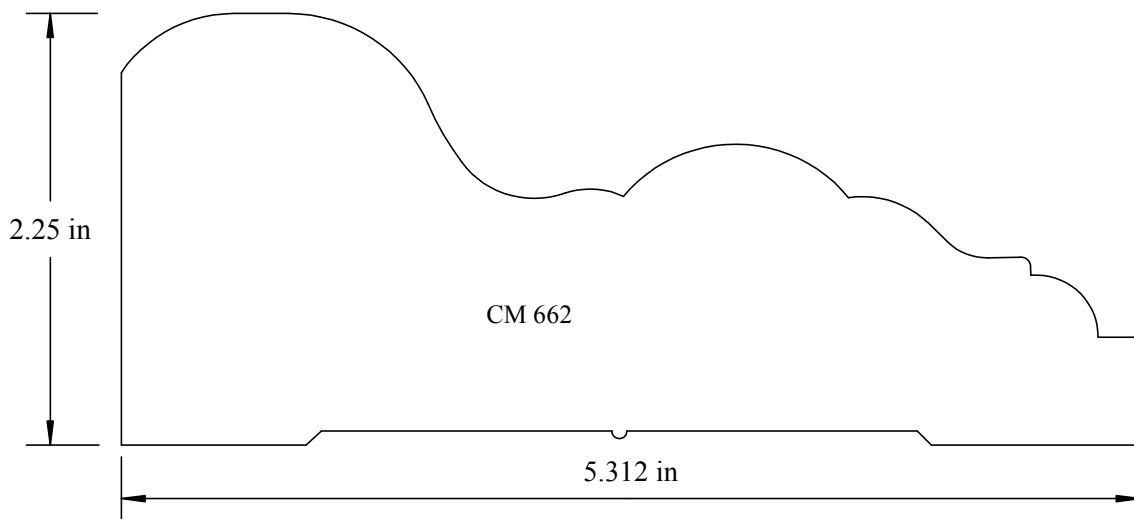
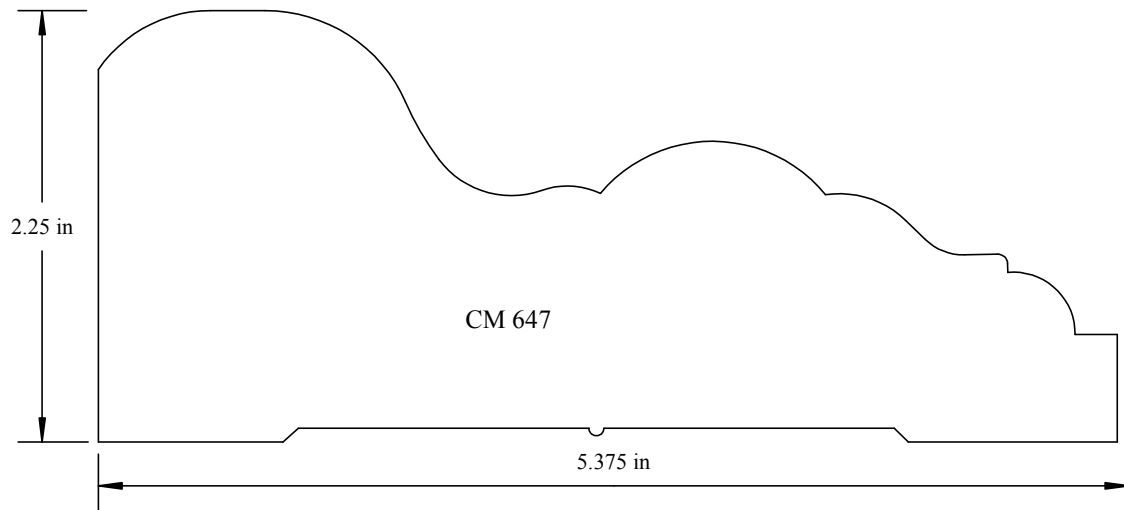
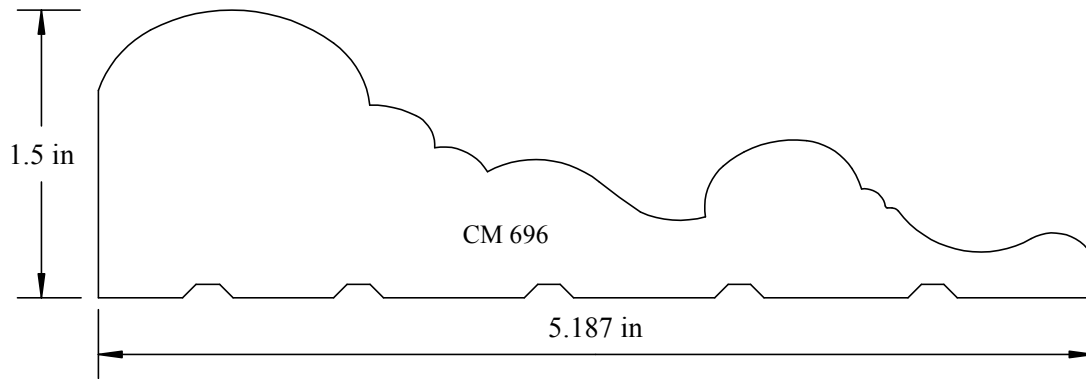

Molding Profiles - Chair Rails

